

# ASD 532

## Aspirating Smoke Detector

Technical description  
as of firmware version 01.04.xx



---

**Manufacturer:**

Securiton AG  
Alpenstrasse 20  
3052 Zollikofen, Switzerland  
[www.securiton.ch](http://www.securiton.ch)

The product (hardware, software and technical documentation) is subject to the copyright of the manufacturer. Any prohibited modification, misuse, copying or prohibited sale of this product represents a violation of the copyright and will be legally prosecuted.

Copyright by Securiton AG

---

## Validity



### Notice

This document is valid only for the product described in this chapter and may be changed or withdrawn without prior notice. The validity of the statements made in this document applies until the statements are revised by a new edition of the document (T number with new index). The user of this document is responsible for staying up to date with its current status through the editor/publisher. We accept no responsibility for claims against any incorrect statements in this document that were unknown to the publisher at the time of publication. Handwritten changes and additions are invalid.

Foreign language documents as listed in this document are always released or changed at the same time as the German edition. If there are inconsistencies between the foreign language document and the German document, the German text is binding.

Some words in this document are highlighted in **blue**. These terms and designations are the same in all languages and are not translated. Users are encouraged to contact the editor/publisher if there are statements which are unintelligible, misleading, incorrect or which contain errors.

This document is intended for trained specialists for mounting, installation, commissioning and maintenance of the product.

This document is available in the following languages:

German	T 140 421 de
English	T 140 421 en
French	T 140 421 fr
Italian	T 140 421 it
Spanish	T 140 421 es
Korean	T 140 421 ko
Portuguese	T 140 421 pt
Russian	T 140 421 ru
Swedish	T 140 421 sv

Current edition:          Index d          13.12.2021          Po/Ksa



### Notice

The following document is applicable to the ASD 532 aspirating smoke detector with the following production version and firmware version:

**Production version**  
from 131221

**Firmware version**  
from 01.04.xx

The validity of older production versions and firmware versions is guaranteed, with the exception of the new functionalities described in this edition. Additional information about the new functionalities can be found in the document history.

## Validity

### Other documents

Data sheet ASD 532	T 140 422	de / en / fr / it / es / ko / pt / ru / sv
Technical description FidesNet	T 140 741	de / en
Material for the sampling pipe	T 131 194	Multilingual (ED / FI)
Commissioning protocol	T 140 423	Multilingual (EDFI)
Data sheets		
XLM 35	T 140 088	de / en / fr / it / es / pt / ru / sv
ML-SFD	T 140 822	de / en / fr / it / es / pt / ru / sv
RIM 36	T 140 364	de / en / fr / it / es / pt / ru / sv
SIM 35	T 140 011	de / en / fr / it / es / pt / ru / sv
SMM 535	T 140 010	de / en / fr / it / es / pt / ru / sv
NCU 900	T 140 742	de / en
RCU 700	T 140 743	de / en
Aspirating Fan Unit AFU 32 mounting instructions	T 140 426	Multilingual (EDFI)

# Contents

<b>1</b>	<b>General</b>	<b>9</b>
1.1	Purpose	9
1.2	Safety and the environment	10
1.2.1	Notice and warning symbols	10
1.2.2	Safety information	10
1.2.3	Disposal	11
1.3	Uses and applications	11
1.4	Abbreviations and terms	11
1.5	Product identification	13
1.6	Guarantee	14
1.7	Product changes	14
1.8	Limitation	14
<b>2</b>	<b>Function</b>	<b>15</b>
2.1	General operating principle	15
2.2	Electrical functional principle	16
2.2.1	Power supply	16
2.2.2	Fan control	17
2.2.3	Microcontroller	17
2.2.4	Programming / operation	18
2.2.5	Displays	19
2.2.6	Relay	19
2.2.7	Outputs	20
2.2.8	Inputs	20
2.2.9	Interfaces	20
2.2.10	Airflow monitoring	21
2.2.11	Smoke sensor monitoring	21
2.2.12	Alarm release	22
2.2.12.1	Alarm 2	22
2.2.12.2	Alarm cascading	22
2.2.12.3	Isolating the smoke sensor	22
2.2.13	Autolearning	23
2.2.14	Day/night control & weekday control	24
2.2.15	Fault triggering	24
2.2.16	Event memory	24
2.2.17	Data logging on the SD memory card	25
2.2.18	Reset types	26
2.2.18.1	State reset	26
2.2.18.2	Hardware reset	26
2.2.18.3	Initial reset	26
2.2.19	ASD network	27
2.2.20	Filter monitoring	27
<b>3</b>	<b>Design</b>	<b>28</b>
3.1	Mechanical	28
3.2	Electrical	30
3.3	Hardware / firmware	31
3.4	List of materials / components	32
3.5	Packaging	32

<b>4</b>	<b>Planning</b>	<b>33</b>
4.1	General aspects of planning	33
4.1.1	Standards, regulations, guidelines, approvals	33
4.2	Area of application	33
4.2.1	System limits	34
4.2.2	Usable accessory materials for the sampling pipe	34
4.3	Planning aids	35
4.3.1	Planning with "ASD PipeFlow" calculation	35
4.3.2	Planning without "ASD PipeFlow" calculation	36
4.4	Space surveillance	36
4.4.1	Space surveillance applications	36
4.4.2	Principles of space surveillance	37
4.4.3	Types of sampling pipe layouts for space surveillance	38
4.4.4	System limits for space surveillance without "ASD PipeFlow" calculation	39
4.4.4.1	Normative system limits for space surveillance without "ASD PipeFlow" calculation	39
4.4.4.2	Non-normative system limits for space surveillance without "ASD PipeFlow" calculation	39
4.4.4.3	System limits for planning without "ASD PipeFlow" calculation	40
4.4.4.4	Non-normative system limits table for planning without "ASD PipeFlow" calculation	41
4.4.4.5	Sampling holes for planning without "ASD PipeFlow" calculation	42
4.4.4.6	Maintenance sampling hole	43
4.5	Equipment monitoring	43
4.5.1	Equipment monitoring applications	43
4.5.2	Principles of equipment monitoring	44
4.5.3	Examples of sampling pipe layouts for equipment monitoring	44
4.5.4	System limits for equipment monitoring without "ASD PipeFlow" calculation	45
4.5.4.1	Alarm thresholds for equipment monitoring using sampling fixtures without "ASD PipeFlow" calculation	45
4.5.5	Sampling fixtures and sampling holes in equipment monitoring	46
4.6	Monitoring air-conditioning and ventilation ducts compliant with EN 54-27	47
4.7	Air recirculation	48
4.8	Settings	49
4.9	Electrical installation	50
4.9.1	Installation cable requirements	50
4.9.2	Determining the conductor cross-section	51
4.10	Restrictions	52
4.11	Environmental influences	53
4.12	Use compliant with UL 268 7 <sup>th</sup> Ed, UL 268A 4 <sup>th</sup> Ed and ULC-S529 4 <sup>th</sup> Ed	53
4.12.1	Use in USA according to UL 268 7 <sup>th</sup> Ed and UL 268A 4 <sup>th</sup> Ed	53
4.12.2	Use in Canada according to ULC-S529 4 <sup>th</sup> Ed	53
<b>5</b>	<b>Mounting</b>	<b>54</b>
5.1	Mounting guidelines	54
5.2	Dimensioned drawing / drilling plan for the detector housing	54
5.3	Material for the sampling pipe	55
5.4	Mounting the detector housing	56
5.4.1	Opening and closing the detector housing	57
5.4.2	Mounting positions for the detector housing	58
5.4.3	Removing the air outlet pipe plug	59
5.4.4	Turning the labelling strip	59
5.5	Mounting the sampling pipe	60
5.5.1	General	60
5.5.2	Mounting with PVC tubes and fittings	60
5.5.3	Mounting with ABS tubes and fittings	60
5.5.4	Mounting with metal pipes and fittings	61
5.5.5	Linear expansion	61
5.5.6	Mounting the sampling pipe	62
5.5.7	Mounting for equipment monitoring	63
5.5.7.1	Screw-free fastening of the sampling pipe	63
5.5.7.2	Transition to a flexible tube	64
5.5.8	Creating the sampling holes	65
5.5.9	Mounting the sampling hole clips and maintenance clips	65
5.5.10	Mounting the sampling funnel	65
5.5.11	Mounting sampling stubs for a ceiling bushing	66
5.5.12	Mounting the dust filter unit, dirt trap box, dust retaining box, water retaining box	67

<b>6</b>	<b>Installation</b>	<b>68</b>
6.1	Regulations	68
6.2	Cable entry	68
6.3	Using the smoke sensor	69
6.4	Installing additional modules	70
6.5	Electrical connection	71
6.5.1	Terminal assignment Main Board AMB 32	71
6.5.2	Terminal assignment for Line module XLM 35 / ML-SFD	72
6.5.3	Terminal assignment for RIM 36 Relay Interface Module	72
6.5.4	Terminal assignment of an SIM 35 Serial Interface Module	72
6.6	Connection variants	73
6.6.1	Power supply	73
6.6.2	Reset input	73
6.6.3	Control	74
6.6.3.1	Control via voltage supply by means of auxiliary relay	74
6.6.3.2	Control via "Reset external" input	75
6.6.4	Connection to the FACP line	76
6.6.4.1	Connection to zone detection via AI / St relays	76
6.6.4.2	Connection to selective identification or addressable loop via AI / St relay	76
6.6.4.3	Connection to SecuriFire / Integral addressable loop from XLM 35 / ML-SFD	77
6.6.5	OC outputs	77
<b>7</b>	<b>Commissioning</b>	<b>78</b>
7.1	General	78
7.1.1	Connect ASD 532 via Ethernet with "ASD Config"	79
7.1.1.1	Topology of the connection between ASD 532 and PC	79
7.1.1.2	Adjust configuration on the PC	79
7.1.1.3	Adjust IP address on the ASD 532	80
7.2	Programming	81
7.2.1	Configuration options	82
7.2.2	Relay allocation	84
7.3	Starting up	84
7.3.1	Commissioning with EasyConfig	84
7.3.2	Commissioning with "ASD Config" configuration software	85
7.3.3	Setting to pre-defined switch positions A11 to C31, W01 to W44	86
7.3.4	Setting and polling the date and time	87
7.3.5	Initial reset	88
7.3.6	Displaying the firmware version	88
7.3.7	Logging off additional modules and the SD memory card	89
7.4	Re-programming	89
7.4.1	Re-programming on the ASD 532	89
7.4.2	Re-programming with "ASD Config" configuration software	89
7.4.3	Re-programming from SecuriFire / Integral with XLM 35 / ML-SFD	89
7.5	Download new firmware to the ASD 532	90
7.5.1	FW upgrade from SD memory card	90
7.5.2	FW upgrade from PC via "ASD Config" configuration software	91
7.6	Measurements	92
7.6.1	Reading out the set configuration and airflow	93
7.6.2	Read out of the set IP configuration	93
7.7	Testing and checking	94
7.7.1	Checking the alarm release	94
7.7.2	Test triggerings	95
7.8	Filter monitoring operation	96
7.9	Commissioning protocol	97

## Contents

<b>8</b>	<b>Operation</b>	<b>98</b>
8.1	Operation and display elements	98
8.2	Functional sequence of operation	99
8.3	Switch positions	100
8.4	Reset	101
8.5	Displays	101
8.5.1	Displays on the control unit	101
8.5.2	Indicators on the AMB 32 main board	102
8.5.3	SD memory card operation	102
8.5.3.1	Data logging on the SD memory card	102
8.5.4	Displaying and reading out the event memory	103
8.5.4.1	Procedure and interpretation of the event memory display	103
8.5.4.2	Event groups	104
8.5.4.3	Event codes within event groups	104
8.5.5	Operation and displays on the XLM 35 or ML-SFD	107
8.5.6	Operation and display on the SIM 35	108
8.5.7	Operation and display on the SMM 535	109
8.6	Operation from SecuriFire / Integral with XLM 35 / ML-SFD	109
<b>9</b>	<b>Maintenance and service</b>	<b>110</b>
9.1	General	110
9.2	Cleaning	110
9.3	Maintenance checks and function checks	111
9.3.1	Filter replacement on dust filter units	113
9.4	Replacing units	114
9.4.1	Replacing the smoke sensor	114
9.4.2	Replacing the aspirating fan unit	114
9.4.3	Replacing the airflow sensor	115
9.4.4	Replacing the AMB 32 Main Board	115
9.5	Disposal	116
9.5.1	Materials used	116
<b>10</b>	<b>Faults</b>	<b>117</b>
10.1	General	117
10.2	Warranty claims	117
10.3	Finding and rectifying faults	118
10.3.1	Fault states	118
<b>11</b>	<b>Options</b>	<b>122</b>
11.1	Sampling pipe	122
11.2	Use under extreme conditions	122
11.3	Use of detector boxes	122
11.4	ASD network	123
11.4.1	ASD networking to "ASD Config" via RS-485 interface from SIM 35 / SMM 535	123
11.4.2	ASD networking to "ASD Config" via the Ethernet interface as of AMB 32	124
11.4.3	ASD networking on FidesNet	124
<b>12</b>	<b>Article numbers and spare parts</b>	<b>125</b>
12.1	Detector housings and accessories	125
12.2	Sampling pipe and accessories	125
<b>13</b>	<b>Technical data</b>	<b>126</b>
<b>14</b>	<b>List of figures</b>	<b>127</b>
<b>Document history</b>		<b>128</b>

# 1 General

## 1.1 Purpose

The ASD 532 aspirating smoke detector has the task of continuously taking air samples via a sampling pipe tube network from a monitored area and feeding the samples to a smoke sensor. Thanks to this detection method and the product's excellent properties under severe ambient conditions, the ASD 532 aspirating smoke detector is used wherever problems are to be expected owing to poorly accessible monitored areas or latent disturbance variables during operation such that optimal protection can no longer be guaranteed with conventional point detectors.

The SSD 532 smoke sensor is used in the ASD 532. It is available in the three following versions and sensitivity ranges:

- SSD 532-1 Alarm sensitivity range 0.5%/m to 10%/m
- SSD 532-2 Alarm sensitivity range 0.1 %/m to 10%/m
- SSD 532-3 Alarm sensitivity range 0.02%/m to 10%/m

The ASD 532 aspirating smoke detector has two slots for additional modules. The following modules can be fitted:

- XLM 35 SecuriLine eXtended Module (only if no ML-SFD fitted)
- ML-SFD M-Line module (only if no XLM 35 fitted)
- RIM 36 Relay Interface Module with 5 relays
- SIM 35 Serial Interface Module (only if no UIM 35 fitted)
- UIM 35 universal interface module (only if no SIM 35 fitted)

With the installation of a eXtended Line Module **XLM 35** resp. M-Line module **ML-SFD** the ASD 532 aspirating smoke detector can be ideally connected to the fire alarm systems SecuriFire and Integral via the addressable loop. Control operations and changes to the ASD device configuration can be carried out directly from the FACP. For this purpose the FACP user software "SecuriFire Studio" and "[Integral Application Center](#)" are used to start the "ASD Config" configuration software for access to the ASDs; the configuration software is then used to make changes to the ASD 532.

A further installation option is the **RIM 36** relay interface module. This module enables the availability of all three pre-signal levels as well as the states "smoke sensor dirty" and "[LS-Ü](#) pipe blockage" as relay contacts. The relays are also freely programmable via the "ASD Config" configuration software.

The **SIM 35** Serial Interface Module is for networking multiple ASD 532 aspirating smoke detectors via RS-485 bus. Using the "ASD Config" configuration software, all ASD 532 units present in the network can be visualised and operated from a PC. The master module in the ASD network is the SMM 535, by means of which a PC is connected.

Another type of ASD networking with the **SIM 35** is provided by the FidesNet. When this is the case, multiple ASD Aspirating Smoke Detectors are networked with each other; decentralised access is available via one or more FidesControl RCU 700s (Remote Control Unit). The FidesNet includes the visualisation and operation of all ASDs connected to the FidesNet on the FidesControl RCUs.



### Notice

The normative alarm transmission of the ASD 532 to the superordinate centre does not take place via the ASD network. For that purpose the "Alarm" / "Fault" relays in the ASD or the SecuriFire / Integral addressable loop are to be used from the XLM 35 or ML-SFD.

The **UIM 35** is the in-house designation for a "Universal Interface Module". This was created for OEM applications and ensures the connection to an OEM system via RS-485 (Modbus protocol) using an OEM own module.

The present technical description contains all information essential for trouble-free operation. For obvious reasons only those details specific to individual countries and companies or special applications can be discussed if they are of general interest.

### 1.2 Safety and the environment

Provided the product is deployed by trained and qualified personnel in accordance with this document, and provided the safety symbols all notices are observed, there is no danger to persons or property under normal conditions and when used properly. The product fulfils the requirements ensuring personal safety and environmental protection during operation. National and state-specific laws, regulations and directives must be observed and adhered to in all cases.

Observe these danger notices. They help prevent accidents and damage.

#### 1.2.1 Notice and warning symbols

The following notice and warning symbols are used to draw attention to hazards and special properties.



#### Danger

The product may represent an immediate danger with a high level of risk to persons if the notice is not duly observed. If the danger is not avoided, death or serious injury may result.



#### Warning

The product may represent a possibly imminent danger with a medium level of risk to persons if the notice is not duly observed. If the danger is not avoided, death or serious injury may result.



#### Caution

The product may represent a possibly imminent danger with a low level of risk to persons if the notice is not duly observed. If the danger is not avoided, a minor injury may result.



#### Notice

If this notice is not observed, the product may malfunction, may cause property damage, or may be harmful to the environment.

#### 1.2.2 Safety information



#### Read the user instructions

To ensure safe and proper use, it is absolutely necessary to read the instructions and other documentation accompanying the product before use and to keep such documentation at hand for later reference. It is imperative that the danger information in particular is observed.



#### Electrostatic discharge

The product includes electronic components that are sensitive to electrostatic discharge (ESD). Contact with persons or objects can cause an electrostatic discharge that damages or destroys the product. ESD bands for preventing electrostatic discharge are used for grounding persons and for equipotential bonding.



1.2.3 Disposal



### Electrical and electronic devices and batteries

It is not permitted to dispose of electrical and electronic devices or batteries in the domestic rubbish. As the end user you are legally obliged to return them. Used electrical and electronic devices as well as batteries can be returned to the seller or taken to a designated recycling centre (e.g. a community collection point or dealer) at no cost.



### Recycling

The product and its components including their packaging consist of recyclable material and can be disposed of for recycling purposes as described in this document.

1.3 Uses and applications

Thanks to the detection method, air sampling by means of a sampling pipe tube network and the good properties of the product under extreme ambient conditions, the ASD 532 aspirating smoke detector is used wherever problems can be expected owing to poorly accessible areas to be monitored or latent disturbance variables during operation such that optimal protection cannot be guaranteed with conventional point detectors. This includes:

- **Space surveillance:**  
EDP rooms, ultra-clean rooms, warehouses, hollow floors, protection of cultural assets, transformer stations, prison cells, etc.
- **Equipment monitoring:**  
EDP systems, electrical distributors, switch cabinets, etc.

The ASD 532 can also be deployed in areas where normally conventional point detectors are used. Local regulations and provisions must be observed from case to case.

The response behaviour of the ASD 532 has been tested in compliance with EN 54-20, Class A, B and C.

When control-unit-specific alarm transmitters, line monitoring elements etc. are used, the ASD 532 can be connected via its potential-free change-over contacts to all common fire alarm systems virtually without restrictions.

1.4 Abbreviations and terms

The following abbreviations and terms are used in this document. The abbreviations for tube material and accessories are listed in a separate document: T 131 194 (see also Sec. 5.3).

µC	= <a href="#">Microcontroller</a> / microprocessor
ABS	= Acrylonitrile-butadiene styrene (plastic)
AFS 32	= Air Flow Sensor
AFU 32	= Aspirating Fan Unit
Al	= Alarm
AMB 32	= ASD main board
ASD	= Aspirating Smoke Detector
<a href="#">ASD Config</a>	= configuration software for the ASD 532
<a href="#">ASD PipeFlow</a>	= Calculation software for the sampling pipe, "ASD PipeFlow" as of Version 2.3
CE	= <a href="#">Communauté Européenne</a> (European Community)
DA	= Detection area
Default	= Preset values / settings
DET	= Detector
DIN	= Deutsche Industrie Norm (German industry standard)
DZ	= Detection zone



## General

Continuation:

EasyConfig	= Commissioning process without the "ASD Config" configuration software
EDP	= Electronic data processing
EEC	= European Economic Community
EEPROM	= Memory component for system data and ASD configuration
EMC	= Electromagnetic compatibility
EN 54	= European standards for fire alarm systems (DE = DIN, CH = SN, AT = Ö-Norm)
Ex-zone	= Area subject to explosion hazards
FACP	= Fire alarm control panel
FAS	= Fire alarm system
Fault	= Fault
FidesNet	= Fire detection systems Net (networking solution, application name)
Flash PROM	= Memory component for firmware
Flush mounting / surface mounting	= Flush mounted / surface mounted
FW	= Firmware
GND	= Supply ground (minus (-) pole)
H-AI	= Main alarm
HF	= High frequency
HW	= Hardware
IEC	= International Electrotechnical Commission
Initial reset	= First start-up on commissioning
IPS 35	= Insect Protection Screen
LED	= Light-emitting diode (indicator)
LS	= Airflow
LS-Ü	= Airflow monitoring
Manufacturer	= Securiton
ML-SFD	= M-Line-Special Fire Detector
NCU	= Network communication unit to the FidesNet "Network Communication Unit" (FidesPort)
NCU Config	= Web application for configuring the FidesNet
OC	= Open collector output
OEM	= Original Equipment Manufacturer (reseller)
PA	= Polyamide (plastic)
PC	= Personal computer
PC	= Polycarbonate (plastic)
PE	= Polyethylene (plastic)
Pin	= Terminal pin
PMR 81	= Semi-conductor relay
Port	= Input or output component
PVC	= Polyvinyl chloride (plastic)
RAM	= Memory component
RCU	= FidesNet remote control unit "Remote Control Unit" (FidesControl)
RIM 36	= Relay interface module
RoHS	= Restriction of Certain Hazardous Substances (eco-friendly manufacturing processes)
SecuriFire	= FAS system
SecuriLine	= Fire detector addressable loop
SIM 35	= Serial Interface Board
SMM 535	= Serial Master Module
SSD 532	= Smoke sensor
St	= Fault
St-LS	= Airflow fault
SW	= Software

→→

Continuation:

Te.	= Terminal
UIM 35	= universal interface module (RS-485)
UMS 35	= Universal Module Support
Update / Release	= Renewal / update of the firmware
V-AI	= Pre-alarm
VDC	= Direct current voltage
VdS	= Association of indemnity insurers, Germany "VdS Schadenverhütung GmbH (DE)"
VKF	= Cantonal fire insurance union, Switzerland "Vereinigung Kantonaler Feuerversicherungen"
VS	= Pre-signal
Watchdog	= Monitoring of the microcontroller
XLM 35	= eXtended Line Module

### 1.5 Product identification

For identification purposes, the ASD 532 and its units have rating plates or identification plates.

The following product identifications apply:

#### Rating plate on the ASD 532 and identification on the packaging

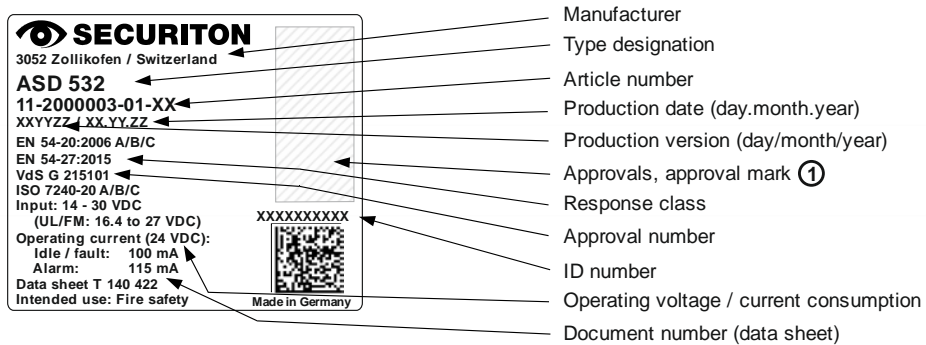

① Additional conformity marks may be affixed to a second rating plate or to an extended area of the rating plate (wider plate).

### Notice

The rating plates, type designations and/or identifications on devices and printed circuit boards must not be removed, written over or defaced in any way.

Many products, such as accessories and mounting materials, are identified only with a sticker showing the article number. The manufacturer identifies these parts by article number.

### 1.6 Guarantee



#### Notice

The product may be operated only with the hardware, software and commissioning media designated and delivered by the manufacturer. Any unauthorised intervention in the hardware and/or software or the use of non-system products is prohibited and may result in malfunctions and/or damage to the product. If this is not observed, all guarantee and warranty rights with respect to the manufacturer of the product will become null and void. Further, non-observance of the user instructions as well as improper maintenance and repair work void the guarantee and product liability.

### 1.7 Product changes

The hardware is considered to comprise the complete detector housing and all the units belonging to the ASD 532 aspirating smoke detector such as sampling pipe and mounting material.

The firmware is located on the [Flash PROM](#) in the ASD 532. An EEPROM is fitted for storing and saving system-specific parameters.



#### Notices

- The ASD 532 is to be operated only with the appropriate original firmware from the manufacturer. Any unauthorised intervention in the firmware or the use of non-original firmware may result in malfunction and/or in damage to the device. Furthermore, all guarantee and warranty rights with respect to the manufacturer of the ASD 532 will become null and void as a result.
- We recommend always using the most recent SW version. In the event of changes by the manufacturer to the hardware or software of a product, there is no guaranteed update for existing systems.

### 1.8 Limitation



#### Notice

Only those smoke sensors in the device approval and in the list below may be used in the ASD 532 aspirating smoke detector. The use of third-party detectors voids the ASD 532 approval issued by the manufacturer.

Smoke sensors of the following type can be fitted in the ASD 532 (see also Sec. 4.10 and 6.6.4):

- SSD 532-1 Alarm sensitivity range 0.5%/m to 10%/m
- SSD 532-2 Alarm sensitivity range 0.1 %/m to 10%/m
- SSD 532-3 Alarm sensitivity range 0.02 %/m to 10%/m

The response sensitivity of the concerned smoke sensor can be adjusted within the above specified range. Depending on the application in accordance with EN 54-20, Class A, B or C, the value is specified via AMB 32 (pre-defined switch positions as described in Sec. 4.4.4 to 4.4.4.3) or based on planning specifications using the ASD PipeFlow calculation software via the “ASD Config” configuration software (see Sec. 7.2.1). The selection of the smoke sensor type with the respective range of sensitivity is based on the information in Sec. 4.4.4.3 or “ASD PipeFlow”.

For use compliant with **UL 268** and **ULC-S529** the alarm sensitivity ranges must be configured as specified in Sec. 4.12.

## 2 Function

### 2.1 General operating principle

In the sampling pipe tube network, the fan generates a vacuum which results in fresh air continuously reaching the detector housing via the sampling pipes. In this way the smoke sensor is constantly supplied with new air samples from the monitored area. Should the smoke concentration exceed the permissible value, the ASD 532 triggers an alarm. The alarm is indicated visually on the ASD 532 and can be transmitted via a potential-free change-over contact to a superordinate fire alarm control panel.

The operational reliability of the aspirating smoke detector depends on the functional reliability of the smoke sensors and on the constant air supply to the system. A fan failure, blockage of the sampling holes or pipe breakage must be communicated to the fire alarm control panel in the form of a fault signal. This condition is satisfied by the airflow monitoring of the ASD 532.

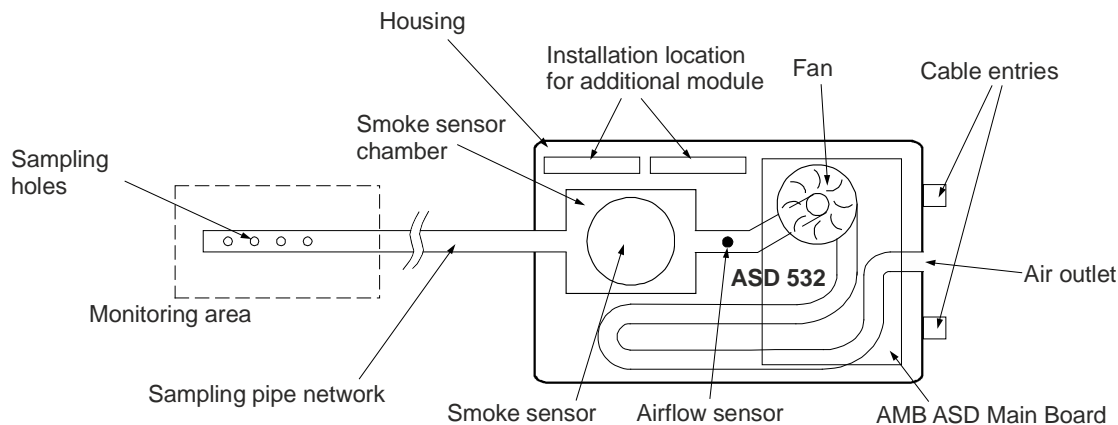

**Fig. 1 General operating principle**

## 2.2 Electrical functional principle

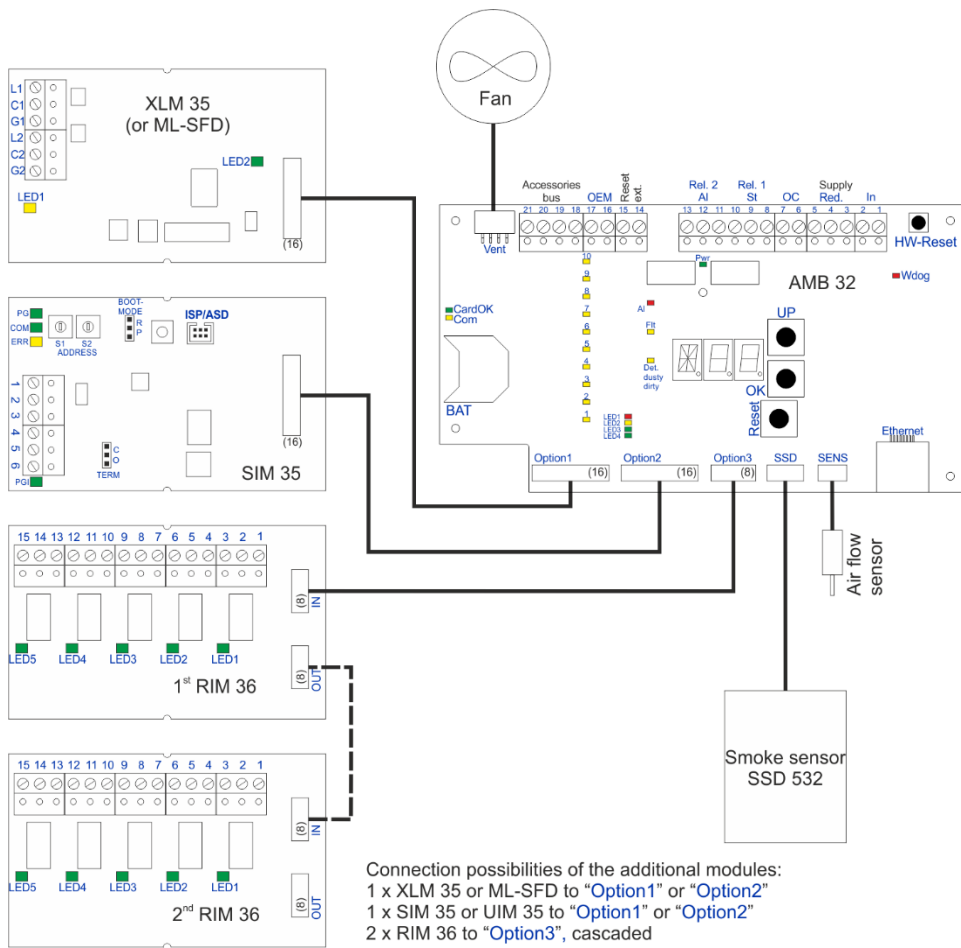

Fig. 2 Block diagram

### 2.2.1 Power supply

The operating voltage of the ASD 532 is +14 to +30 VDC (UL/FM = 16.4 to 27). On the AMB 32 Main Board, 5 VDC of the operating voltage is diverted for internal voltage use.

The operating voltage is monitored on the AMB 32 for undervoltage. If the operating voltage falls below 13.0 VDC (+0 / -0.3 VDC), the ASD 532 triggers an undervoltage fault.

### 2.2.2 Fan control

The physical and electrical properties of a fan cause a brief power surge when it is switched on and starts up, which in turn affects the conductor dimensioning and the total power consumption of the fire alarm system.

A specially designed circuit therefore ensures that the fan cannot exceed a specific maximum power consumption in its start-up phase. When the ASD 532 is switched on, the computer-controlled fan speed starts up slowly. After the fan has been powered up, the speed is kept constant.

Any blocking of the fan is detected by evaluating the motor speed. If the specified threshold is undershot, the fan supply is switched off and a fault is signalled.

Depending on the size of the system and/or environment, the fan can be operated at different speeds (by means of the "ASD Config" configuration software). This is useful primarily in critical areas (long pipes) to increase the transport speed in the sampling pipe tube network (high speed) or to reduce the noise level in cases where the noise level produced by the fan is a disturbance (low speed). The following fan speed levels can be selected:

Level	Speed (rpm)	Effect
I	5250	Low transport speed / low noise level
II	6900	Normal transport speed / reduced noise level
III	9300	High transport speed / normal noise level



#### Notices

- The fan speed levels can be changed only with the "ASD Config" configuration software.
- For applications and commissioning **without** "ASD Config" configuration software, **Level II** must always be set.
- If the fan speed is changed (by using the "ASD PipeFlow" calculation software), ensure that the maximum permissible transport time according to EN 54-20 is not exceeded.
- After the fan speed has been changed, it is **imperative** that a new initial reset is carried out (observe waiting time of at least 2 min).

### 2.2.3 Microcontroller

The entire program and switching sequence is controlled by a microcontroller. The firmware is stored on a **Flash PROM**. System-specific configurations are stored in an EEPROM.

The program is monitored by the internal watchdog of the microcontroller. In the event of a failure of the microcontroller circuit, an emergency fault is triggered. This is signalled on the device by the steady lit "**Fault**" LED. The "Fault" relay switches.

2.2.4 Programming / operation

The operation of the ASD 532 aspirating smoke detector in normal mode (after commissioning) is limited to switching on/off or to resetting a triggered event (alarm/fault). Operation is generally via the FACP, with input of the “Zone On/Off” and “Reset” functions (on “Reset external” input of the ASD 532).

Events triggered on the ASD 532 can be reset locally using the “Reset” key on the control unit or by briefly actuating the “Reset External” input. The reset is possible only if the triggered event is no longer pending (e.g. smoke sensor no longer has smoke). The application of a continuous signal at the “Reset external” input also deactivates (switches off) the ASD 532 (see also Sec. 2.2.8 and 6.6.2).



**Notice**  
A local reset does not reset a higher-order FACP. It may happen that the reset in the ASD 532 triggers a fault in the superordinate line of the FACP.

To aid commissioning the ASD 532, there are two 7-segment displays, an alphanumeric display, and two keys (“UP” and “OK”) inside the device on the AMB 32 Main Board. These elements provide a type of rotary switch function, i.e. displays and positions in the range **A00** to **Z99** may appear.

These elements are used when commissioning the ASD 532. Device settings for predefined system limits can also be called up – **EasyConfig**. These pre-defined positions are stored with normative values for response sensitivity, airflow monitoring (LS-Ü) and pipe configuration. They also contain positions which allow deviations from the normative limits with regard to airflow monitoring. The **EasyConfig** process allows the device to be commissioned without the “ASD Config” software. If system-specific programming has to be carried out (e.g. after a calculation with “ASD PipeFlow” or when programming RIM 36), the “ASD Config” configuration software must be used.

Fig. 3 shows the workflow for defining and programming project-specific device functions.

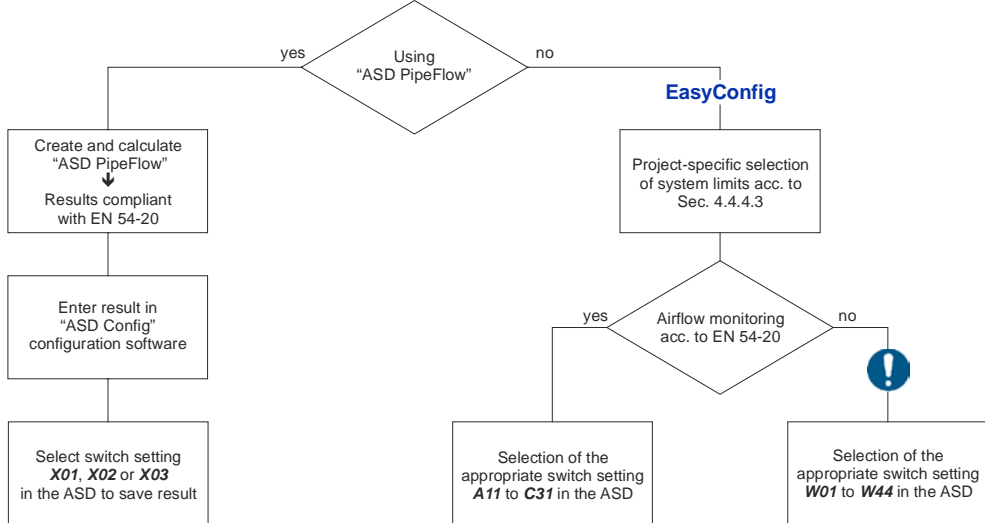



Fig. 3 Workflow for project-related programming



**Notice**  
Switch settings **W01** to **W44** may be used only after consulting with the manufacturer. The airflow monitoring values stored under those switch positions are not tested in accordance with EN 54-20.

The description of the predefined positions and the operator structure is found in Sec. 4.4.4.3, 4.4.4.4, 7.2.1 and 8.3.

### 2.2.5 Displays

Events are displayed by LEDs on the control unit. Displays are present:

- operation, fault, alarm smoke sensor dirt, smoke level indicator level 10.

Depending on the event, the LEDs are either continuously lit or flash at different frequencies (see Sec. 8.5).

### 2.2.6 Relay

On the AMB 32 and depending on the installed additional modules, the ASD 532 has several relays with potential-free change-over contacts with the following assignments:

Unit	Relay designation	Function, events
AMB 32	Rel. 1: ① Fault	Fault (all events) ASD inactive
	Rel. 2: Alarm	Smoke sensor alarm release
1 <sup>st</sup> RIM 36 (from AMB 32)	Rel. 1	Pre-signal 1 of smoke sensor or freely programmable
	Rel. 2	Pre-signal 2 of smoke sensor or freely programmable
	Rel. 3	Pre-signal 3 of smoke sensor or freely programmable
	Rel. 4	Smoke sensor dirt or freely programmable
	Rel. 5	Sampling pipe blockage or freely programmable
2 <sup>nd</sup> RIM 36 (cascaded from 1 <sup>st</sup> RIM 36)	Rel. 1	Freely programmable
	Rel. 2	Freely programmable
	Rel. 3	Freely programmable
	Rel. 4	Freely programmable
	Rel. 5	Freely programmable



#### Notice

- ① The "Fault" relay has picked up in the release state → contact Te. 10/8 closed, 10/9 open (ASD 532 under voltage; no fault event present).

## Function

### 2.2.7 Outputs

There are two OC outputs (OC [Fit](#) and OC [AI](#)) on the ASD 532. Parallel indicators, feedback indicators or other consumers (relays) can be connected to these outputs. The outputs are configured with the following criteria (see also Sec. 6.6.5):

Unit	OC designation	Function, events
AMB 32	OC <a href="#">Fit</a>	Fault (all events) / ASD inactive
	OC <a href="#">AI</a>	Smoke sensor alarm release

### 2.2.8 Inputs

The ASD 532 has an “**External reset**” input used to reset the device to its normal state after an event. The input is potential-free (opto-isolator). It can be actuated both on the “plus” and on the “minus” side. The input operates in the 5 to 30 VDC range and has a pulse bandwidth of 0.5 to 10 s. When a continuous signal is applied for longer than 20 s, the ASD 532 is deactivated (fault state) (see also Sec. 6.6.2). Switching inactive via the “Reset external” input works only if the ASD 532 is not equipped with an XLM 35 or ML-SFD.

The “**OEM**” input is for actuating alarms or faults from third-party detectors. The “**OEM**” input can also be used for activating the day/night control. The input is potential free (optocoupler) and can be actuated “plus” or “minus” side in the range of 5 to 30 VDC. By default the input is not enabled and must be parameterised using the “ASD Config” configuration software (OEM input signal). It actuates the alarm and fault states on the ASD (relay + LED). The same delay times and latching states as for triggering from the SSD 532 apply.



#### Notices

- In some cases actuations via the OEM input may **not** comply with requirements **in accordance with EN 54-20** and may therefore only be used after consulting with the manufacturer.
- The input is **not** line monitored.

### 2.2.9 Interfaces

Depending on the installed additional modules, the ASD 532 has the following interfaces:

Unit	Designation	Function, events
AMB 32	Ethernet / TCP/IP	Configuration with “ASD Config” Update of the firmware
	SD memory card	Record operating data Update of the firmware
XLM 35	L1 / C1 / G1 // L2 / C2 / G2	SecuriFire / Integral addressable loop
ML-SFD	P1 / N1 / S1 // P2 / N2 / S2	SecuriFire / Integral addressable loop
SIM 35	GND / D + / D –	RS-485

### 2.2.10 Airflow monitoring

Airflow monitoring is based on the calorimetric measuring method (mass flow rate measuring method).

An airflow sensor is installed in the detector housing in such a way that any change in the sampling pipe (pipe breakage, pipe blockage) can be evaluated.

If there is an initial reset of the device and the sampling pipe is intact, the data of the airflow measurement is registered and saved as reference values (100%). The system sets the values in the middle of an electronically formed monitoring window. In the event of a shift in the values (actual values) out of the monitoring window ( $\pm xx\%$ ) owing to pipe blockage or pipe breakage in the sampling pipe, the ASD 532 triggers an "airflow fault". The monitoring window can be set to different sizes on the ASD 532.

A variable delay time ensures that disturbance variables, e.g. air turbulence, are ignored. To handle fluctuations in the ambient temperature, the ASD 532 is equipped with a temperature compensation circuit.



#### Notice

A requirement for the correct operation of the airflow monitoring is that the airflow is logged when the ASD 532 is commissioned. With the triggering of an initial reset, the data is acquired and saved in the ASD 532 as reference values (see also Sec. 2.2.18, "Reset types").

According to **EN 54-20** a change in the airflow that is greater than  $\pm 20\%$  must be reported as a fault. After the initial reset the airflow is displayed as 100% in the ASD 532 aspirating smoke detector when the sampling pipe is correct and clean. In the switch positions **A11** to **C31** any change in this value greater than  $\pm 20\%$  – i.e. below 80% (dirt/pipe blockage) or above 120% (pipe breakage) – triggers an "airflow fault" after the **LS-Ü** delay time of **300 s** has expired.



#### Notice

Switch positions **W01** to **W44** are stored with airflow monitoring values which are **not tested according to EN 54-20** and may therefore only be used after consulting with the manufacturer.

### 2.2.11 Smoke sensor monitoring

The smoke sensor used on the ASD 532 is monitored on the AMB 32 Main Board. A failure of the sensor electronics, a dusty or dirty smoke sensor is registered as an event code and displayed as a state or fault (dust; only state display, fault triggering only via RIM 36). Likewise, the connection line between the smoke sensor and the AMB 32 is monitored and a fault is signalled if there is a failure.

To avoid false alarms, the SSD 532 smoke sensors used in the ASD 532 have a technical measure (TM) for comparing fire parameter pattern matching (measure for verifying the alarm state according to DIN VDE 0833-2).

### 2.2.12 Alarm release

The smoke sensor cyclically transmits its state as well as the signal amplitude / smoke level to the AMB 32 main board. The state of the smoke sensor is processed further on the AMB 32. If the set threshold values (alarm, pre-signal 1–3) are exceeded, the corresponding state “**Alarm**”, “**Pre-signal 1–3**” is triggered on the ASD 532.

#### 2.2.12.1 Alarm 2

The “ASD Config” configuration software offers the possibility of also enabling an “**Alarm 2**” for the ASD 532. When activated, that alarm is **always above** the smoke sensor “**alarm**” described in Sec. 2.2.12 (minimum 20%). If the set limit for alarm 2 is exceeded, no additional display is actuated on the ASD 532. Alarm 2 can also be programmed on a RIM relay. Alarm 2 is always a follow-up alarm to the EN 54-20 alarm and is therefore not subject to the response requirements of EN 54-20. The setting options for alarm 2 using the “ASD Config” configuration software can be found in Sec. 7.2.1 (Table A).

#### 2.2.12.2 Alarm cascading

The “ASD Config” configuration software offers the possibility of activating a cascading scenario for the alarm release. This means that the activated pre-signals 1 to 3 and the alarm are triggered one after the other according to the set delay times (pre-signal delay and alarm delay).



#### Notices

- The cascading function may not comply with **EN 54-20** requirements and may therefore only be used after consulting with the manufacturer.
- When used according to **UL 268** and **ULC-S529** it is to be noted that the ASD 532 employs a maximum alarm verification time delay of **30 s** (adjustable).

#### 2.2.12.3 Isolating the smoke sensor

This function is used to place the ASD 532 in an isolated state using the “ASD Config” configuration software. This means that test alarms can then be triggered on the ASD 532 without activating superordinate systems (FACP) (relays / OC outputs / XLM / ML-SFD do not trigger). When the “Isolate” function is switched on, a fault is triggered on the ASD and forwarded to the superordinate centre. On the ASD the “Fault” LED is then continuously lit.

The “Isolate” state is also triggered when the “Filter replacement” procedure is activated (see Sec. 2.2.20 and 7.8).

### 2.2.13 Autolearning

With the **Autolearning** function the ASD 532 is able to monitor the ambient air over a defined period of time (adjustable from one minute to 14 days) via the sampling pipe and send the results to the system; based on that it can then determine the ideal trigger threshold of the smoke sensors. This prevents operational disturbance variables such as dust, vapour and smoke from triggering false alarms on the ASD 532. It means it is also possible to set a highly sensitive trigger threshold (far below the trigger threshold requirements of EN 54-20), for example for clean rooms. During **Autolearning** the biggest amplitude of the smoke sensors is determined and then multiplied by an adjustable factor of 1.1 to 10 to define the final trigger threshold. The finally determined trigger threshold, however, can never be less than the minimum possible trigger threshold (depending on the smoke sensor type, see example 2) and not greater than the trigger threshold for fulfilling the EN 54-20 requirement (see example 3). If the day/night control is activated, the values for both time periods are determined separately.

#### Example 1:

- Smoke sensor type = SSD 532-2 (0.1–10%/m)
- Required trigger threshold as per system limit and “ASD PipeFlow” for EN 54-20, Class C = 0.4 %/m
- Selected **Autolearning** factor = 2
- Maximum amplitude (smoke level) during **Autolearning** = 31%/m

Calculation:  $0.31 \times 2 \times 0.4 \text{ %/m} = 0.248 \text{ %/m}$

Result: Trigger threshold of the smoke sensor = **0.248%/m**

#### Example 2:

- Smoke sensor type = SSD 532-3 (0.02–10%/m)
- Required trigger threshold as per system limit and “ASD PipeFlow” for EN 54-20, Class A = 0.03%/m
- Selected **Autolearning** factor = 1.1
- Maximum amplitude (smoke level) during **Autolearning** = 50 %/m

Calculation:  $0.5 \times 1.1 \times 0.03 \text{ %/m} = 0.0165 \text{ %/m}$

Result: Trigger threshold of the smoke sensor = **0.02%/m** (minimum possible trigger threshold of the SSD 532-3)

#### Example 3:

- Smoke sensor type = SSD 532-2 (0.1–10%/m)
- Required trigger threshold as per system limit and “ASD PipeFlow” for EN 54-20, Class C = 0.2%/m
- Selected **Autolearning** factor = 10
- Maximum amplitude (smoke level) during **Autolearning** = 16%/m

Calculation:  $0.16 \times 10 \times 0.2 \text{ %/m} = 0.32 \text{ %/m}$

Result: Trigger threshold of the smoke sensor **remains at 0.2%/m and thereby fulfils the EN 54-20 Class C requirement.**



#### Notices

- Norm-compliant alarm release during **Autolearning** is guaranteed; the procedure is interrupted. Likewise, **Autolearning** is aborted if during the procedure a change in the configuration takes place (change among the switch settings **A11–C31**, **W01–W44** and **X01–X03**). If there is a power interruption on the ASD (power supply line) during **Autolearning**, it will be restarted once the supply voltage is restored. In the event of a disablement (triggered from the FACP or using “Reset External”), **Autolearning** is interrupted and then re-started after re-activation. Also for “Isolate” and “Filter replacement”, **Autolearning** is interrupted and restarted after revoking the concerned state.
- **Autolearning** can only be used with the “ASD Config” configuration software and in switch positions **X01 – X03**.
- During **Autolearning** both the point (watchdog display) and the **AL** text flash on the segment display.

### 2.2.14 Day/night control & weekday control

The ASD 532 can be adapted to operational processes (e.g. if dust, vapour and/or smoke are produced during working hours) using the day/night control. When the day/night control is activated, different trigger thresholds, pre-signal allocations (smoke level only, not relays) or **LS-Ü** parameters can be assigned for each time slot (see Sec. 2.2.13).



#### Notices

- Improper parameter changes in day/night operation may result in non-compliance with the EN 54-20 norm.
- Day/night control can be used only via the “ASD Config” configuration software.
- The activation of the day/night control can be performed from the ASD clock (in accordance with time/ week-day program in “ASD Config”), FACP or via the OEM input “**OEM**”.
- Day/night control is effective only in switch positions **X01 – X03**.
- On non-activated days of the week, night mode of operation is always selected (when activating from the ASD clock).
- In addition to the watchdog indicator (flashing point in the left segment display), the point is also continuously lit on the right segment display whenever the day/night control is active (only with the selected switch positions **X01 – X03**).

### 2.2.15 Fault triggering

If a fault occurs on the ASD 532, the “Fault” relay is de-energised and the “**Fault**” display is activated. In the event of a fault the fault profile can also be localised using the event code display on the AMB 32 (switch position **E**) (see also Sec. 8.5.4.3 and 10.3.1). The following events trigger a fault (list is incomplete):

- Fault: airflow (after expiry of **LS** delay time)
- Fault: fan (fan limit data exceeded or fallen short of, tacho signal)
- Initial reset fault
- Fault: smoke sensor dirty
- Fault: smoke sensor missing; communication disrupted; other
- AMB 32 communication fault to XLM 35 / ML-SFD / RIM 36 / SIM 35 / UIM 35 (individual)
- Emergency fault (microcontroller failure)
- Undervoltage fault (13.0 VDC, +0 / –0.3 V)
- Fault: power supply (no voltage on the ASD, no “**Fault**” display)
- ASD inactive via “External reset” input.



#### Notice

The “Fault” relay has picked up in the release state → contact Te. 10/8 closed, 10/9 open (ASD 532 under voltage; no fault event present).

### 2.2.16 Event memory

The ASD 532 has an event memory capable of storing up to 1,000 events. The latest (i.e. most recent) event is always placed in the first position. If the memory exceeds 1,000 events, the oldest event is deleted. The event memory as a whole can be deleted only by the manufacturer. The event memory can be read out directly on the ASD 532 using the rotary switch function (switch position **E** = last 99 events, see Sec. 8.5.3) or using the “ASD Config” configuration software (up to 1,000 events can be selected).

### 2.2.17 Data logging on the SD memory card

**Measurement values:** All relevant measurement values are written to the SD memory card every second (default, can be changed with "ASD Config") for each sensing tube and saved in **Log-Files** (\*.xls file). After 28,800 entries (corresponding to 8 hours with an SD memory card interval of 1 s), a new **Log-File** is automatically generated. A total of 251 **Log-Files** (L000.xls to L250.xls) can be generated for long-term logging. After the last **Log-File** the oldest one (L000.xls) is overwritten. The 251 **Log-Files** are sufficient to cover 83 days of data logging (with SD memory card interval of 1 s). The **Log-Files** can be opened in Excel and the data processed with the diagram assistant to create charts.

**Events:** All events which occur in the ASD 532 are written to the **Event-Files** (\*.aev file). After 64,000 events a new **Event-File** is created automatically. A total of 10 **Event-Files** (E000.aev to E009.aev) can be generated for long-term logging. After the last **Event-File** the oldest one (E000.aev) is overwritten. The 10 **Event-Files** are sufficient to log over 640,000 events. The **Event-Files** can be opened with a text editor. Please refer to Sec. 8.5.3 for the interpretation of the events. There is also the possibility of importing **Event-Files** using the "ASD Config" configuration software and displaying them as real event text.

### 2.2.18 Reset types

All events triggered on the ASD 532 go into latching mode whenever the default configurations are used. To reset, carry out a state reset.

The following reset types are possible (see Sec. 2.2.18.1 to 2.2.18.3).

#### 2.2.18.1 State reset

A state reset is triggered by pressing the “Reset” key on the control unit or by actuating the “Reset external” input (see also Sec. 6.6.2). The state reset can be triggered only after an event, and only if the criterion that resulted in the event trigger is back in the normal state (e.g. smoke level in the smoke sensor is again below the trigger threshold or a fault event is rectified). As a result of the state reset, the ASD 532 continues to run “normally” and the fan does not stop.

#### 2.2.18.2 Hardware reset

A hardware reset is triggered if there is a brief interruption in the supply voltage or if the “HW reset” key is briefly pressed on the AMB 32 (see also **Fig. 41** and **Fig. 46**). This restarts the ASD 532. The fan stops and then slowly starts up again (start-up control). The previously programmed parameters of the ASD 532 are retained (system-specific configurations).



#### Notice

##### Attention: fire incident control, remote alerting!

A hardware reset briefly triggers the fault relay (approx. 1 s). Before maintenance work is carried out on the ASD 532, it is therefore essential to switch off the fire incident controls and remote alerting on superordinate systems (FACP).

#### 2.2.18.3 Initial reset

An initial reset is triggered according to the information in Sec. 7.3.5.

With an initial reset, the currently valid airflow measuring values are read in and saved. All subsequent airflow changes take the measuring values at the time of the initial reset as a basis. An initial reset does not discard the previously defined installation-specific parameters (system limits, response class).



#### Notices

- During commissioning as well as after changes to the sampling pipe (length, repairs) or after changing the fan speed, it is **imperative** that an initial reset is carried out. An initial reset must also be carried out after repair work on the ASD 532 (replacement of airflow sensor, aspirating fan unit, AMB 32 main board).
- After an FW upgrade, an initial reset is required only if expressly mentioned in the relevant firmware description.
- When carrying out an initial reset, make sure the sampling pipe has been correctly implemented (sealed connecting points, sampling holes correctly drilled).
- If an initial reset has to be repeated because a triggered fault in the airflow monitoring cannot be reset, it should only be carried out if **all** the necessary measures for cleaning the sampling pipe have been implemented beforehand (including dust filter unit, see also Sec. 9.3). If an initial reset is carried out with blocked or dirty sampling holes, there is the danger that insufficient or no air samples will be taken and hence the ASD 532 will no longer be able to trigger an alarm.
- Before carrying out an initial reset, allow the fan to run for a minimum of 2 minutes (after switching on or after making changes to the sampling pipe).

### 2.2.19 ASD network

An ASD network can be implemented by using the SIM 35 and SMM 535 additional modules or via the Ethernet interface. An ASD networking can also be done using SIM 35 and FidesNet or Ethernet interface and FidesNet. Please refer to Sec. 11.4 ff for more information.

### 2.2.20 Filter monitoring

If a dust filter unit is installed in the sampling pipe, it can be monitored by means of connectible filter monitoring functions. The degree of soiling of the filter element is not monitored but rather the application-specific “filter service life” defined in the ASD. The filter service life is set to 3 months by default; it can, however, be parameterised system-specifically from 1 to 24 months (see Sec. 9.1 for setting the number of months). After expiry of this filter service life, a “Filter fault (service life exceeded)” is triggered on the ASD. This fault trigger occurs only workdays at 10:00 a.m. (Monday to Friday, provided the time and date are correctly set) and can be reset once. After a waiting time of 14 days, another fault is triggered that can be reset only by replacing the filter element.

The “Filter replacement” function must be activated on the ASD in order to replace the filter element. The options for this are listed below. When filter replacement is activated, the aspirating smoke detector is set to the “Isolate” state. This insures that during the replacement work falling dust particles from the filter element do not cause a false alarm. After the filter has been replaced, the “Filter replacement” procedure is completed by pressing the “Reset” key on the ASD. This cancels the “Isolate” state and resets the fault on the ASD. “Filter service life” monitoring is restarted at 0.

The following filter monitoring operations are available on the ASD 532:

- Filter monitoring On/Off;
- Change filter service life (in months, 1 – 24);
- Read out filter service life (configured and expired);
- Activate (start) filter replacement via *EasyConfig*;
- Activate (start) filter replacement by pressing the “Reset” key longer than 15 s (provided the filter monitoring and the “Reset” key are activated);
- Finish filter replacement by pressing the “Reset” key again, or via “ASD Config” > “Filter replaced” or “Deactivate isolation”.

The functions can be accessed directly on the ASD via *EasyConfig* operation (switch position *d*) or via the “ASD Config” programming software.

### 3 Design

#### 3.1 Mechanical

The ASD 532 aspirating smoke detector consists of the detector housing and a sampling pipe tube network. The sampling pipe is made of hard PVC or ABS tubes with an external diameter of 25 mm and an internal diameter of 20 mm (see also Sec. 5.3). In special applications – e.g. in extremely corrosive environments – other tube materials can also be used, subject to the specifications set out in Sec. 5.3. The sampling pipe has several sampling holes whose size is such that each hole extracts the same amount of air. The sampling pipe may be I-, U-, T-, H-, or E-shaped. The sampling pipe is symmetrically designed in principle. Asymmetrical sampling pipe tube networks can also be implemented with the help of the “ASD PipeFlow” calculation software.

The housing cover on the detector housing is opened by means of four rotary snap locks.

Integrated in the detector housing is a fan which, in conjunction with the sampling pipe, ensures an uninterrupted supply of air to the detector housing. Airflow monitoring detects any pipe blockages and pipe breakages in the sampling pipe.

There is one chamber for the smoke sensor in the detector housing. The air channel through the smoke sensor and fan are separated from the other parts inside the detector housing; this means the ASD 532 is able to remain fully operational during commissioning and maintenance work even when the housing cover is open.

The AMB 32 Main Board contains the processor-controlled evaluation electronics and the connection technology. There are two slots in the detector housing for installing optional additional modules (XLM 35, ML-SFD, RIM 36, SIM 35, UIM 35).

Pre-defined labelling strips are used for labelling the control unit in the housing cover. If the device is mounted in a position rotated by 180°, the labelling strip can be turned accordingly.

Smoke sensors of the following type can be fitted in the ASD 532 (see also Sec. 4.10 and 6.6.4):

- SSD 532-1 Alarm sensitivity range 0.5%/m to 10%/m
- SSD 532-2 Alarm sensitivity range 0.1 %/m to 10%/m
- SSD 532-3 Alarm sensitivity range 0.02 %/m to 10%/m



#### Notice

The XLM 35, ML-SFD, RIM 36, SIM 35 and UIM 35 additional modules are optionally available and are built into the ASD 532 when setting up the system. A maximum of two modules can be fitted.

**Bottom part of detector housing**

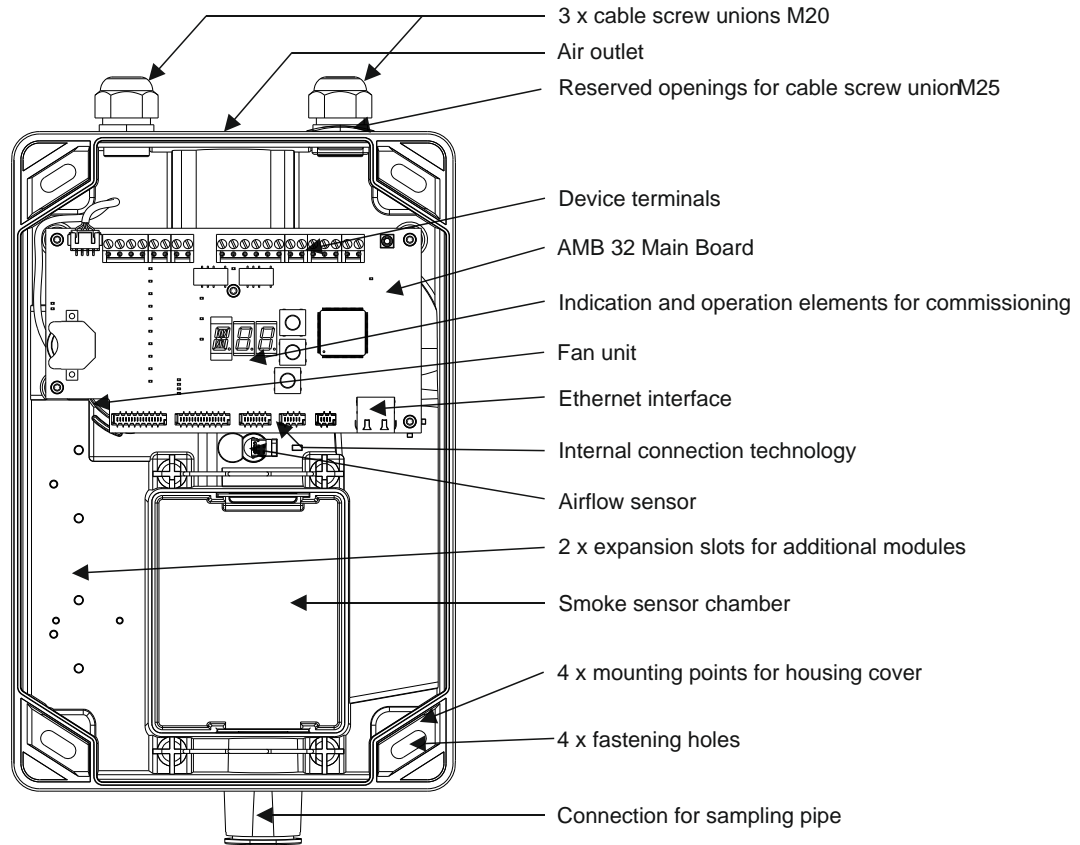

**Housing cover**

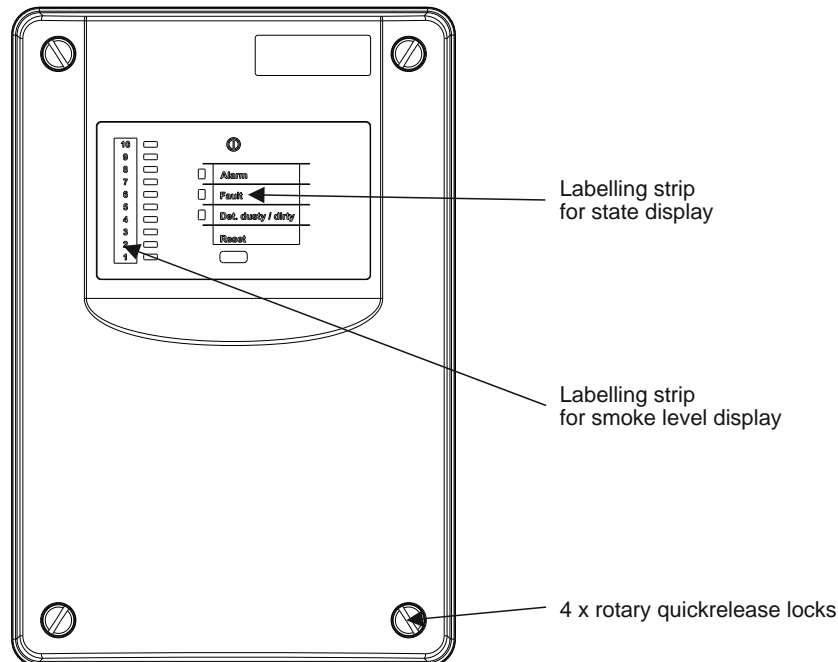

**Fig. 4 Mechanical design**

### 3.2 Electrical

The electrical design of the ASD 532 comprises the following:

- AMB 32 Main Board
- Smoke sensor (SSD 532-1, -2, -3)
- Fan
- Airflow sensor
- Additional modules XLM 35, ML-SFD, RIM 36, SIM 35, UIM 35.

The following circuit components and elements are on the AMB 32 Main Board:

- Power supply unit with switching controller
- Fan control with airflow evaluation and temperature measurement
- Smoke sensor evaluation
- 1 opto-isolator input for receiving optional smoke detector states (OEM)
- Opto-isolator input for external reset
- Driver components for actuating the relays and open collector outputs
- Microcontroller with ports, RAM, [Flash](#) PROM, EEPROM, etc.
- Lithium battery
- RTC clock
- Two keys, one alphanumeric and two 7-segment displays for configuration setting
- 10 LEDs for smoke level indicator
- 4 LEDs for displaying operation, alarm, fault, dust and dirt
- 2 relays with potential-free change-over contacts for fault, alarm
- Terminal blocks with pluggable screw terminals for the device connection
- Ethernet interface (device)
- LED for hardware watchdog
- SD memory card holder
- 2 LEDs for SD memory card signals
- Two 16-pin ribbon cable connectors ([Option1](#) and [Option2](#)) for connecting the XLM 35, ML-SFD, SIM 35, UIM 35
- One 8-pin ribbon cable connector ([Option3](#)) for connecting to two RIM 36 units (cascaded)
- One 6-pin ribbon cable connector for connecting to the smoke sensor
- One 4-pin ribbon cable connector for connecting to the air flow sensor
- HW reset button.

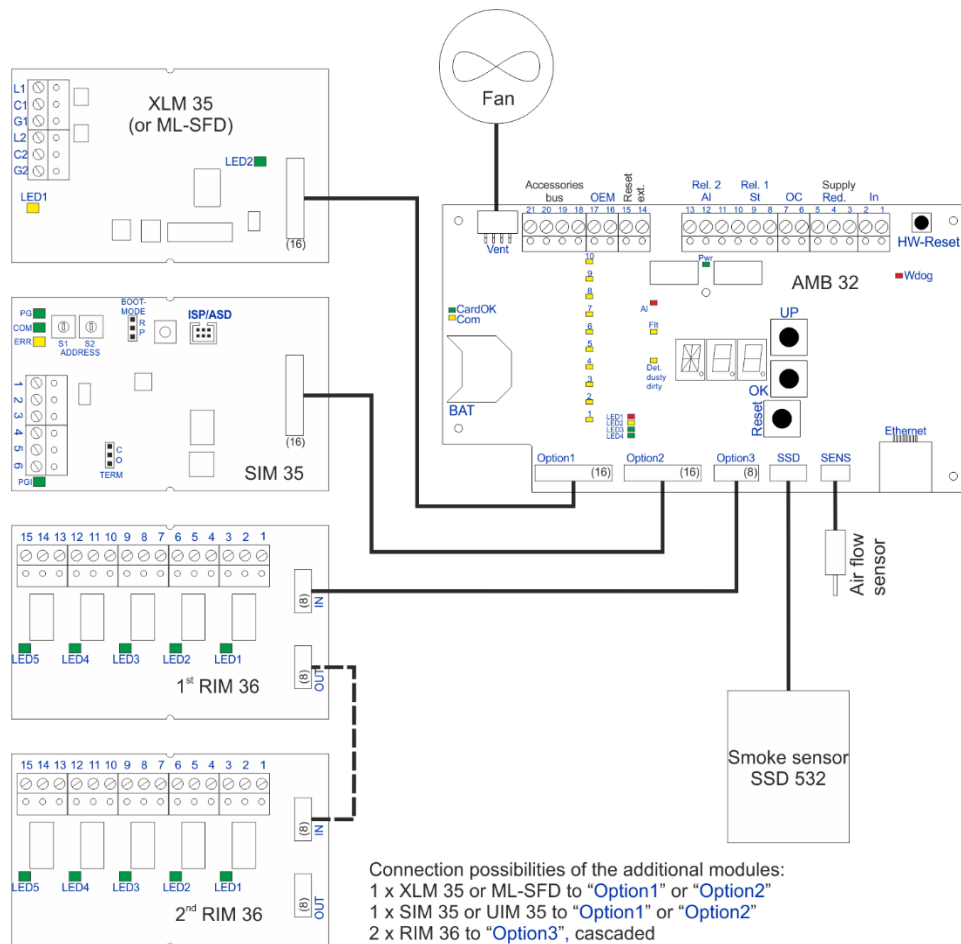

Fig. 5 Electrical design

### 3.3 Hardware / firmware

The hardware is considered to comprise the complete detector housing and all the units belonging to the ASD 532 aspirating smoke detector such as sampling pipe and mounting material.

The firmware is stored on the [Flash](#) PROM in the ASD 532. An EEPROM is fitted for storing and saving system-specific parameters.

Notices

!

- The ASD 532 is to be operated only with the appropriate original firmware from the manufacturer. Any unauthorised intervention on the firmware or the use of non-original firmware may result in malfunction and/or in damage to the device. Furthermore, all guarantee and warranty rights with respect to the manufacturer of the ASD 532 will become null and void as a result.
- We recommend always using the most recent SW version. In the event of changes by the manufacturer to the hardware or software of a product, there is no guaranteed update for existing systems.

## 3.4 List of materials / components

The following materials is included in the ASD 532 on **delivery** (see also Sec. 5.1, 5.3, 9.5.1 and 11.4.2):

	AMB 32	Prepared for Smoke sensor	Commissioning protocol	Smoke sensor	XLM / ML-SFD / RIM / SIM / UIM
ASD 532	Yes	Yes	Yes	-- (accessories)	-- (accessories)
The mounting set comprises: 3 x company plates, 2 x M20 blind plugs, 4 x S6 dowels, 4 x Torx wood screws (Ø 4.5 x 40 mm), 4 x M4 U-washers (Ø 4.3/12 x 1 mm)					

The following **accessory material** is available:

	Smoke sensors	XLM 35 / ML-SFD	RIM 36	SIM 35 / UIM 35
ASD 532	1 x SSD 532-1, -2, -3	1 x possible	2 x possible	1 x possible

The **material for the sampling pipe** can be purchased separately from the manufacturer in the required quantities, based on the size and use of the system. This material is listed separately in document **T 131 194** (see also Sec. 5.3, 9.5.1 and 11.4.2).



### Notice

The material for the sampling pipe is a component of the VdS device approval. Only the materials listed and approved by the manufacturer may be used when setting up the system, see T 131 194. Materials from other sources may be used only if the manufacturer's written consent has been obtained.

A special **tool** is required for mounting and handling the ASD 532 (Torx screws). Please refer to the list in Sec. 5.1.

## 3.5 Packaging

The detector housing is delivered in a customised cardboard sleeve sealed with adhesive tape. The packaging is recyclable and can be reused.

The mounting set and installation material sundries are packed in recyclable bags. The sampling tube is supplied in sections (approx. 4–5 m). The flexible tube is supplied in 50 m rolls.

The contents of the packaging are specified as described in Sec. 1.5.



### Notices

- Electronic components such as printed circuit boards are supplied in antistatic protective packaging. These components should be removed from the packaging just shortly before use or mounting.
- Only devices with unbroken or unopened seals (adhesive tape seal) are considered new. Packaging should not be opened until immediately before use.
- The cardboard packaging of the detector housing can be stacked up to ten times its weight.
- The packages of the ASD 532 are suitable for post or rail shipment only to a limited extent.
- For transport in or to tropical regions, marine transport, etc., the appropriate measures must be taken (special packaging as provided by the shipper).

## 4 Planning

### 4.1 General aspects of planning

#### 4.1.1 Standards, regulations, guidelines, approvals

Section 4 “Planning” below is a guideline for planning the ASD 532 aspirating smoke detector. These guidelines address the direct application only insofar as it applies to compliance with EN 54-20 and is required to ensure technically trouble-free operation.



#### Notices

- The use of special fire alarm systems such as the ASD 532 is subject in some cases to country-specific regulations and guidelines and must therefore be approved by the relevant technical bodies and authorities (insurance companies) prior to implementation.
- For many uses that are country, facility and application specific there are planning guidelines, application examples and applicable regulations and directives. These documents can be requested from the manufacturer of the ASD 532 system or from the responsible technical bodies and authorities.
- The country-specific regulations and guidelines apply as a matter of principle to the intended use, planning and application of the ASD 532 aspirating smoke detector. In any case the country-specific specifications always take precedence over the planning specifications outlined below.

The ASD 532 aspirating smoke detector complies with the requirements of European Standard EN 54-20, Class A to C. The following applies:

- EN 54-20, Class A                    highly sensitive
- EN 54-20, Class B                sensitive
- EN 54-20, Class C                standard

### 4.2 Area of application

To comply with a required system configuration, the ASD 532 can be connected via its potential-free change-over contacts or by using control-panel-specific line modules (e.g. XLM 35 / ML-SFD) to all common fire alarm systems virtually without restrictions. The following factors determine which system configuration is best suited and should be used:

- Laws, regulations, guidelines
- Customer requirements;
- System type and area of application;
- Circumstances specific to the building
- New system, replacement of an existing system, expansion
- Cost/benefit ratio

## Planning

### 4.2.1 System limits

The use of an ASD 532 aspirating smoke detector is subject to the system limits listed below and compliance with EN 54-20 requirements. Depending on the planning process, the system limits as set out in Sec. 4.4 and 4.5 **also** apply.

	Class A	Class B	Class C
Max. overall length of the sampling pipe tube network (incl. any air recirculation)	120 m	120 m	120 m
Max. length from ASD to farthest sampling hole	70 m	70 m	70 m
Max. number of sampling holes	8	12	16

### 4.2.2 Usable accessory materials for the sampling pipe

Depending on the selected planning method – *with “ASD PipeFlow” calculation* according to Sec. 4.3.1 or *without “ASD PipeFlow” calculation* according to Sec. 4.3.2 – the following accessory materials can be used for the sampling pipe (a complete list of approved materials for the sampling pipe is provided in document T 131 194):

ASD 532		
↳ Planning →	without “ASD PipeFlow”	with “ASD PipeFlow”
↳ Configuration via →	EasyConfig or “ASD Config”	“ASD Config”
<b>Filter</b>		
FBS 25 PC (use only below 0°C)	*	✓
DFU 911	*	✓
<b>Dust trap box / dust retaining box / water retaining box</b>		
DTB 25 PC	*	✓
DRB 25	*	✓
WR 25 / WRB 25	*	✓
<b>Capillary sampling tube</b>		
TU 6 PVC	*	✓
<b>Heating accessories</b>		
All heating accessories	*	*
<b>Detonation flame arrester</b>		
DFA 25-1 / DFA 25-2 / DFA 25-3	*	*
<b>Automatic blow-out devices</b>		
ADB 1000 / ADB 2000	*	✓
ADB 500 (no VdS approval)	*	✓
<b>Detector box</b>		
REK 511	*	✓

### 4.3 Planning aids

#### 4.3.1 Planning with “ASD PipeFlow” calculation

The “ASD PipeFlow” calculation software is used for planning the sampling pipe tube network. Its purpose is to design on a drawing the pipe layouts required for implementing a system and assign the sampling holes. The “ASD PipeFlow” calculation software provides a selection of different tube materials, fittings and accessory parts (dust filter unit, water retaining boxes, etc.). The end result of the calculation software specifies the parameters required for a norm-compliant trigger in accordance with EN 54-20, Class A to C, after which the parameters are programmed on the ASD 532. It is also necessary to select the smoke sensor type with the appropriate sensitivity range corresponding to the response sensitivity calculated by “ASD PipeFlow”.

Asymmetrical sampling pipe tube networks can also be planned and set up using the “ASD PipeFlow” calculation software. System limits for EN 54-20 compliant triggering are defined in the calculation software.

The material stored in the “ASD PipeFlow” calculation software for the sampling pipe – and the “ASD PipeFlow” calculation software itself – are an integral part of the VdS device approval. A list of the available materials for the sampling pipe is provided in a separate document (T 131 194).

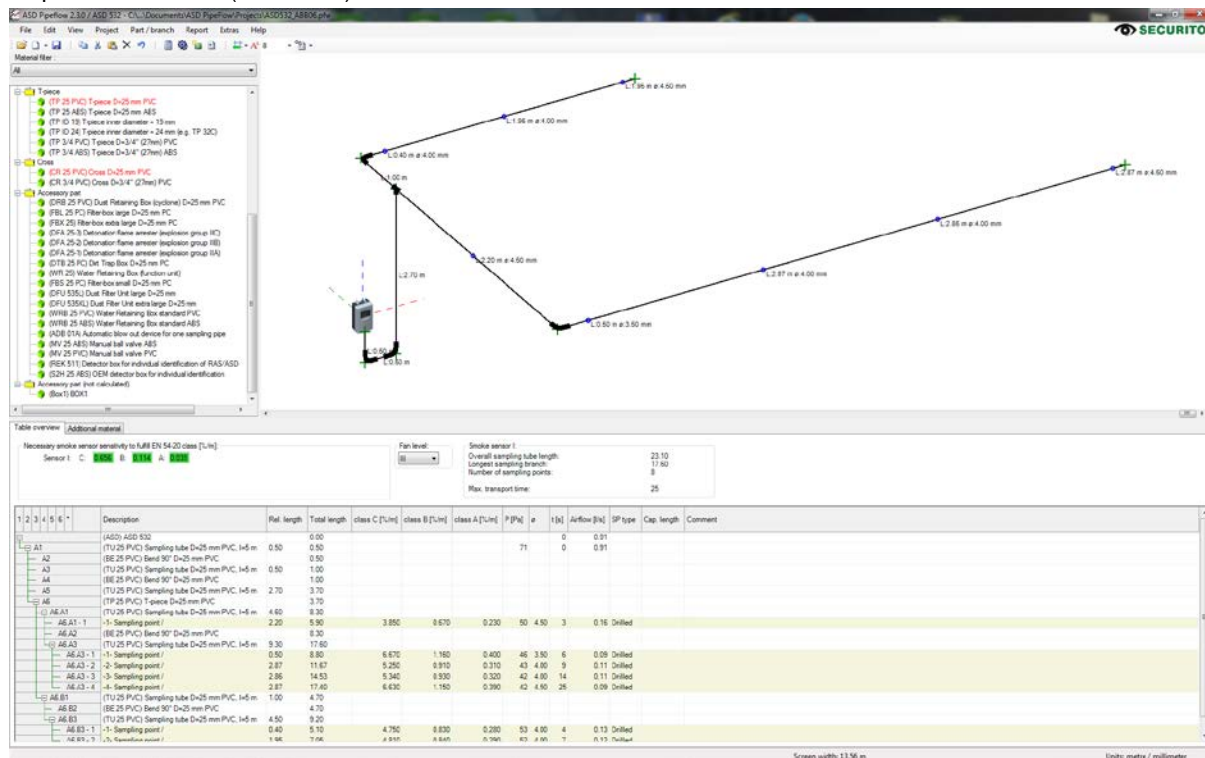

Fig. 6 “ASD PipeFlow” program interface

**Notice about modernising existing systems with the ASD 532**

When modernising existing systems (aspirating smoke detectors other than ASD 532), the existing sampling pipe tube network must be re-calculated using the “ASD PipeFlow” calculation software. The existing sampling pipe must be cleaned and checked (inspected for damage) prior to commissioning.

**Notice about ensuring a minimum airflow ASD 532**

When planning with “ASD PipeFlow”, it is necessary to check that the volume airflow is at least 0.1 l/s (indicated in “ASD PipeFlow” > “Table view” > Row “(ASD) ASD 532”). For very short pipe systems with 1 or 2 sampling holes, it may happen that “ASD PipeFlow” suggests small sampling holes in range of 2.0 / 2.5 mm diameter so that the volume airflow is less than 0.1 l/s. In this case, select sampling holes in the pipe system that are bigger (see Sec. 4.4.4.5). The result requires a new “calculate” (not “optimise”) in “ASD PipeFlow” with these larger sampling holes, and the suggested response sensitivity must be programmed in ASD 532.

### 4.3.2 Planning without “ASD PipeFlow” calculation

If planning is performed **without** “ASD PipeFlow”, there are a number of switch settings in the ASD 532 saved with pre-defined values which are necessary for actuation in compliance with EN 54-20, Class A–C. The selection of a smoke sensor type with the corresponding sensitivity range depends on the response class and system limits (see Sec. 4.4.4.3).



#### Notices: Planning without “ASD PipeFlow” calculation

- Sampling pipe networks are principally arranged symmetrically (including sampling holes). Any deviation in symmetry must not exceed  $\pm 10\%$ .
- The maximum tube lengths and number of sampling holes specified in Sec. 4.4.4.3 must not be exceeded.
- Only the tube materials listed in document T 131 194 with a diameter of 25 mm are to be used (including flexible hose).
- A **maximum of two 90° angles** may be used per sampling pipe. Any other changes of direction that may be necessary in the sampling pipe are to be implemented with 90° bends.
- For each tube network, a maximum of the following accessory parts may be used:
- When using other tube and accessory parts (e.g. more than two 90° angles, flexible tubes, dust filter unit, dust trap boxes), it is imperative that you use the “ASD PipeFlow” calculation software.
- The “ASD PipeFlow” calculation software must be used when planning equipment monitoring.
- The “ASD PipeFlow” calculation software must also be used in applications with air recirculation.

## 4.4 Space surveillance

### 4.4.1 Space surveillance applications

The ASD 532 aspirating smoke detector can also be used for the following applications:

- Spaces where point detectors are difficult to mount due to poor accessibility, e.g.:
  - cable galleries, cable tunnels, false ceilings, hollow floors
  - machine halls, production halls
  - low and high voltage rooms
  - computer rooms, clean rooms
- Spaces where, for aesthetic reasons, point detectors should not be mounted, e.g.:
  - Protection of cultural assets
  - Museums
- Spaces where point detectors could be damaged, e.g.:
  - Prison cells
  - public passageways
- Spaces with localised smoke development, e.g.:
  - warehouses with diesel forklifts
- Spaces with a high level of dust pollution and/or high atmospheric humidity.



#### Notice

Applications with a high level of dust and/or high atmospheric humidity require the use of accessory parts as recommended by the manufacturer, e.g.: dust filter unit, dirt trap box, water retaining box or three-way tap for sporadic cleaning of the sampling pipe with compressed air (see also Sec. 5.5.12).

#### 4.4.2 Principles of space surveillance



##### Notices

The following principles apply to space monitoring:

- The number and arrangement of the ASD 532 units are based on the size of the space.
- In general the monitoring areas are the same as for point-type detectors. Guidelines that apply to specific objects – e.g. high-rack storage buildings – must be observed.
- The sampling pipe tube networks are to be laid out in such a way that any anticipated fire is detected in its initial stages.
- The aspirating smoke detectors should be positioned in such a way that false alarms are avoided.
- When planning **without** “ASD PipeFlow” calculation, make sure the sampling pipe tube networks are laid out symmetrically (including sampling holes). Any deviation in symmetry must not exceed  $\pm 10\%$ .
- When planning **without** “ASD PipeFlow” calculation, the maximum tube lengths and number of sampling holes specified in Sec. 4.4.4.3 must **not** be exceeded.
- $90^\circ$  bends are to be used instead of  $90^\circ$  angles for any changes in direction. An excessively high number of direction changes significantly affects detection time.
- When planning **without** “ASD PipeFlow” calculation, do not use more than **a maximum of two  $90^\circ$  angles** per sampling pipe. Any other changes of direction that may be necessary in the sampling pipe are to be implemented with  $90^\circ$  bends.
- The minimum sampling pipe length is **1 m** for all applications.
- Several rooms may be monitored by one and the same aspirating smoke detector only if so permitted by the relevant guideline (e.g. DIN VDE 0833-2, Germany; VKF, Switzerland).
- Most national application guidelines specify maximum heights for room monitoring of high rooms. If no limits are present, the limits in “FIA Code of Practice” Table 3 can be applied.

## 4.4.3 Types of sampling pipe layouts for space surveillance

Typical layout types for space surveillance are I-shaped, U-shaped, T-shaped, H-shaped and E-shaped sampling pipe tube networks. Other sampling pipe layout designs can also be planned using the “ASD PipeFlow” calculation software.

When planning **with** “ASD PipeFlow” calculation, irregularly spaced sampling holes are also possible (**Fig. 7**).

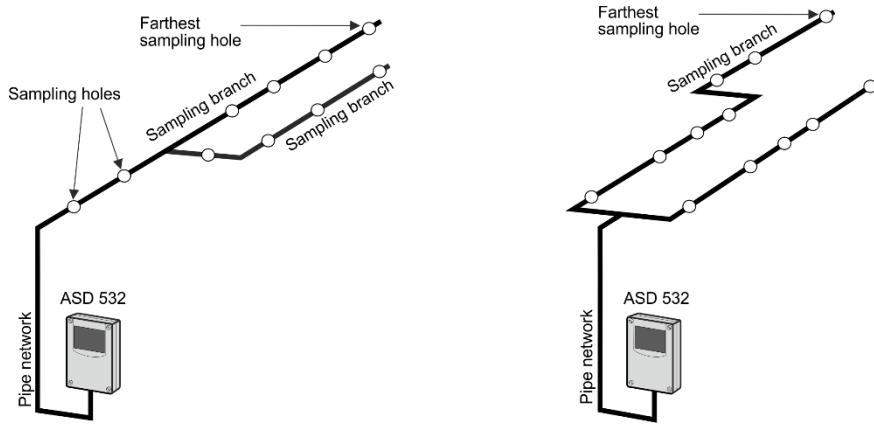

**Fig. 7** Examples of planning with “ASD PipeFlow” calculation

If planning **without** “ASD PipeFlow” calculation, make sure the sampling pipe tube networks are set up symmetrically (max. symmetry deviation of  $\pm 10\%$ ). This applies to the tube layout and the spacing between the sampling holes (**Fig. 8**).

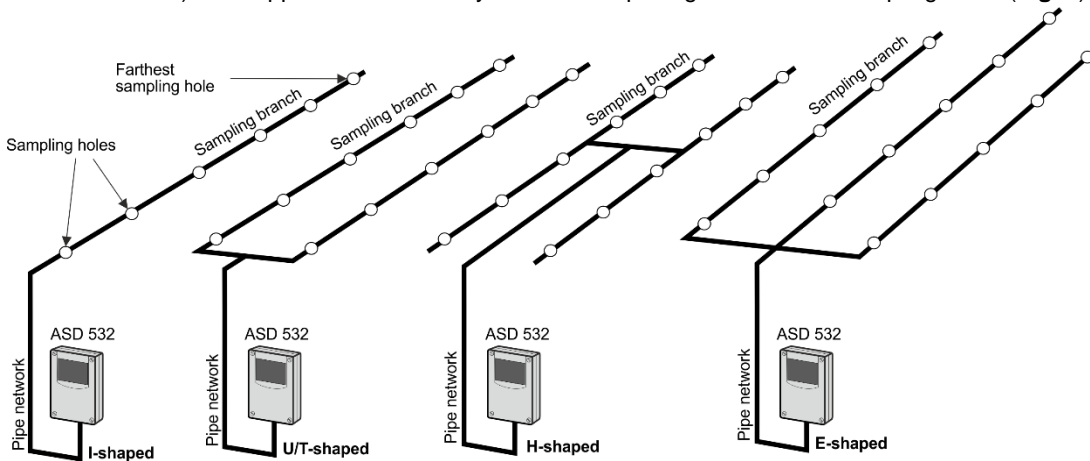

**Fig. 8** Examples of planning without “ASD PipeFlow” calculation

#### 4.4.4 System limits for space surveillance without “ASD PipeFlow” calculation

The system limits specified in this section apply to planning without using the “ASD PipeFlow” calculation software. Stored under the system limits are switch positions with pre-defined values. There are two areas, with the following meaning:

- normative system limits according to EN 54-20, Class A to C, switch positions **A11** to **C31**;
- Non-normative system limits, switch settings **W01** to **W44**.

**Fig. 9** below illustrates the possible sampling pipe tube networks with definitions of tube length specifications. The maximum tube lengths and number of sampling holes as well as the required smoke sensor types are found in the tables in Sec. 4.4.4.3 based on response class.

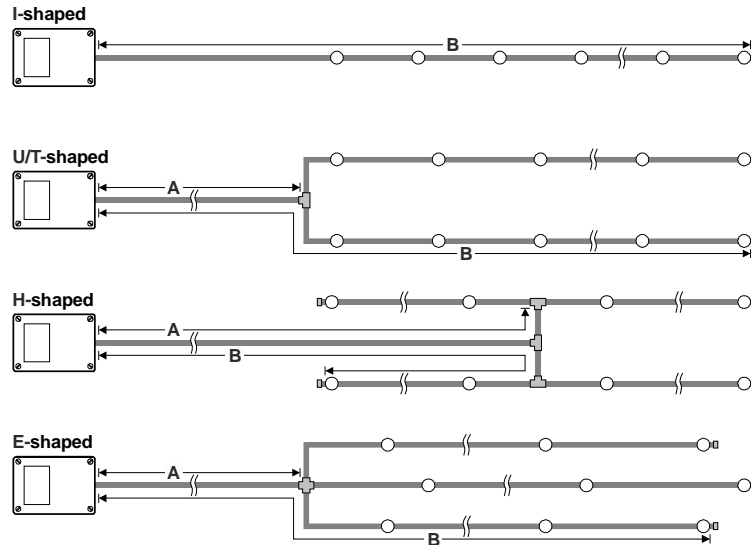

**Fig. 9 Sampling pipe definitions**

##### 4.4.4.1 Normative system limits for space surveillance without “ASD PipeFlow” calculation

Stored under switch positions **A11** to **C31** are values which are necessary in terms of alarm response sensitivity and airflow monitoring for compliance with EN 54-20 Class A to C. The switch position designation is deciphered as follows:

- First digit            Response grade **A, b, C** (A = highly sensitive, b = sensitive, C = standard)
- Second digit        System limit **1, 2, 3** (tube network length, number of sampling holes)
- Third digit          Tube networks **1** (number of sampling pipe tube networks on the ASD 532, **only 1 possible**).

Example: **b21**            response grade **b** / system limit **2** / **1** sampling pipe tube network

##### 4.4.4.2 Non-normative system limits for space surveillance without “ASD PipeFlow” calculation

Switch positions **W01** to **W44** contain system limits which fulfil **only** the alarm response sensitivity compliant with EN 54-20 Class A to C, **but not** the normative limits with regard to airflow monitoring. As they are identical with the system limits **A11** to **C31** in terms of tube topology (tube network length, number of sampling holes), the switch positions **W01** to **W44** are also included in the tables 4.4.4.3 below. For more details about switch positions **W01** to **W44** with regard to airflow monitoring, please refer to Sec. 4.4.4.4.

**Notice**

Switch settings **W01** to **W44** may be used only after consulting with the manufacturer. The airflow monitoring values stored under those switch positions are **not** tested in accordance with EN.

## Planning

### 4.4.4.3 System limits for planning without “ASD PipeFlow” calculation

#### Compliant with EN 54-20, Class A (highly sensitive)

Shape	System limit	Switch position compliant with EN 54-20	Switch position not standards compliant 	Smoke sensor type SSD 532	Alarm threshold (%/m)	Length from ASD to the last T-piece/cross (Fig. 9 “A”)	Max. length from the ASD to the farthest sampling hole (Fig. 9 “B”)	Number of sampling holes per sampling branch	Max. total length of the sampling pipe
I	1	A11	W01 – W04	–3	0.045	---	40 m	1 – 6	40 m
U / T	1	A11	W01 – W04	–3	0.045	1 – 20 m	40 m	1 – 3	80 m
H	1	A11	W01 – W04	–3	0.045	1 – 20 m	25 m	1 – 2	100 m
E	1	A11	W01 – W04	–3	0.045	1 – 20 m	30 m	1 – 2	90 m

#### Compliant with EN 54-20, Class B (sensitive)

I	1	b11	W09 – W12	–2	0.255	---	30 m	1 – 4	30 m
	2	b21	W17 – W20	–3	0.090	---	40 m	5 – 8	40 m
U / T	1	b11	W09 – W12	–2	0.255	1 – 20 m	30 m	1 – 2	60 m
	2	b21	W17 – W20	–3	0.090	1 – 20 m	40 m	3 – 4	80 m
H	1	b11	W09 – W12	–2	0.255	1 – 20 m	20 m	1	80 m
	2	b21	W17 – W20	–3	0.090	1 – 20 m	25 m	2 – 3	100 m
E	1	b11	W09 – W12	–2	0.255	1 – 20 m	20 m	1	60 m
	2	b21	W17 – W20	–3	0.090	1 – 20 m	30 m	2 – 3	90 m

#### Compliant with EN 54-20, Class C (standard)

I	1	C11	W25 – W28	–1	1.090	---	30 m	1 – 4	30 m
	2	C21	W33 – W36	–2	0.645	---	40 m	5 – 8	40 m
	3	C31	W41 – W44	–2	0.305	---	60 m	9 – 12	60 m
U / T	1	C11	W25 – W28	–1	1.090	1 – 10 m	20 m	1 – 2	40 m
	2	C21	W33 – W36	–2	0.645	1 – 20 m	30 m	3 – 4	60 m
	3	C31	W41 – W44	–2	0.305	1 – 20 m	40 m	5 – 6	80 m
H	1	C11	W25 – W28	–1	1.090	1 – 10 m	15 m	1	60 m
	2	C21	W33 – W36	–2	0.645	1 – 20 m	20 m	2	80 m
	3	C31	W41 – W44	–2	0.305	1 – 20 m	25 m	3 – 4	100 m
E	1	C11	W25 – W28	–1	1.090	1 – 10 m	20 m	1 – 2	60 m
	2	C21	W33 – W36	–2	0.645	1 – 20 m	25 m	3	75 m
	3	C31	W41 – W44	–2	0.305	1 – 20 m	30 m	4	90 m



### Notices

- Switch settings **W01** to **W44** may be used only after consulting with the manufacturer. The airflow monitoring values stored under store switch positions are **not** tested in accordance with EN (see Sec. 4.4.4.4).
- The diameter of the sampling holes is specified in the tables in Sec. 4.4.4.4.
- Physically the sampling holes are to be spaced so that the resulting monitoring areas comply with country-specific guidelines.
- The overall length of the sampling pipe must not exceed the system limits as set out in Sec. 4.2.1.
- The specifications apply when there are no accessory parts. When using accessory parts in the sampling pipe, it is imperative that the “ASD PipeFlow” calculation software is used.

**4.4.4.4 Non-normative system limits table for planning without “ASD PipeFlow” calculation**

The following table shows the parameters for switch settings **W01** to **W44** that do not conform to EN 54-20 concerning airflow monitoring. It also shows the number of tube networks for these switch settings. The tube topology specifications (tube network length, number of sampling holes) are shown in the tables in Sec. 4.4.4.3.

 <b>Notice</b> Switch settings <b>W01</b> to <b>W44</b> may be used only after consulting with the manufacturer. The airflow monitoring values stored under those switch positions are <b>not</b> tested in accordance with EN.					
	Switch release compliant with EN 54-20	System limit	Airflow monitoring		Switch position
			Delay time	Deviation	
highly sensitive	A	1	10 min	± 20%	W01
			60 min	± 20%	W02
			10 min	± 50%	W03
			60 min	± 50%	W04
sensitive	B	1	10 min	± 20%	W09
			60 min	± 20%	W10
			10 min	± 50%	W11
			60 min	± 50%	W12
		2	10 min	± 20%	W17
			60 min	± 20%	W18
			10 min	± 50%	W19
			60 min	± 50%	W20
Default	C	1	10 min	± 20%	W25
			60 min	± 20%	W26
			10 min	± 50%	W27
			60 min	± 50%	W28
		2	10 min	± 20%	W33
			60 min	± 20%	W34
			10 min	± 50%	W35
			60 min	± 50%	W36
		3	10 min	± 20%	W41
			60 min	± 20%	W42
			10 min	± 50%	W43
			60 min	± 50%	W44

# Planning

## 4.4.4.5 Sampling holes for planning without “ASD PipeFlow” calculation

To ensure that all the sampling holes take in the same amount of air, the diameter of the sampling hole on the sampling tubes fitted must increase as the distance from the detector housing increases.

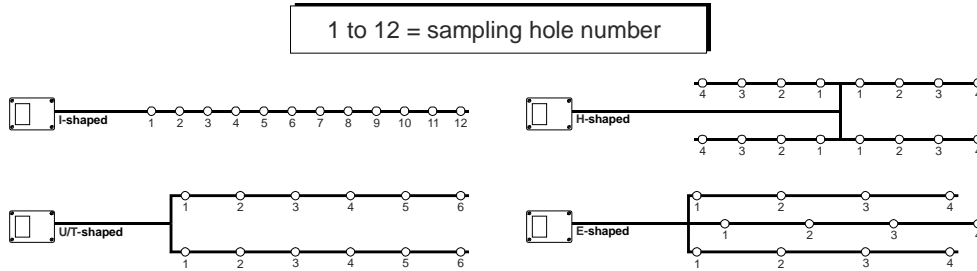

**Fig. 10 Size of sampling holes**

The tables below show the respective hole diameters for the numbers in **Fig. 10** as a function of the number of sampling holes per sampling branch (this applies also to high-rack storage facilities).

If required, the sampling holes can be created using the special “sampling hole clips”. The sampling hole clips are available in various sizes (i.e. with hole diameters as indicated in the table above: 2.0 / 2.5 / 3.0 / 3.5 / 4.0 / 4.5 / 5 / 5.5 / 6 / 6.5 / 7 mm). See also Sec. 5.5.9.

I-shaped sampling pipes												
Number of sampling holes	Hole diameter in mm for the sampling hole number counted from the detector housing:											
	1	2	3	4	5	6	7	8	9	10	11	12
1	5.0											
2	4.0	5.0										
3	4.0	4.0	5.0									
4	3.5	3.5	4.0	5.0								
5	3.5	3.5	3.5	4.0	5.0							
6	2.5	2.5	2.5	2.5	3.0	5.0						
7	2.5	2.5	2.5	2.5	2.5	2.5	5.0					
8	2.5	2.5	2.5	2.5	2.5	2.5	2.5	5.0				
9	2.5	2.5	2.5	2.5	2.5	2.5	2.5	2.5	5.0			
10	2.0	2.0	2.0	2.5	2.5	2.5	2.5	2.5	3.0	7.0		
11	2.0	2.0	2.0	2.0	2.5	2.5	2.5	2.5	2.5	4.0	7.0	
12	2.0	2.0	2.0	2.0	2.0	2.0	2.5	2.5	2.5	2.5	4.0	7.0

U/T-shaped sampling pipes						
Number of sampling holes per sampling branch	Hole diameter in mm for the sampling hole number counted from the detector housing:					
	1	2	3	4	5	6
1	5.0					
2	4.0	5.0				
3	4.0	4.0	5.0			
4	4.0	4.0	4.0	5.0		
5	4.0	4.0	4.5	5.0	6.5	
6	3.0	3.0	3.5	3.5	4.0	6.5

H/E-shaped sampling pipes				
Number of sampling holes per sampling branch	Hole diameter in mm for the sampling hole number counted from the detector housing:			
	1	2	3	4
1	5.0			
2	4.0	5.0		
3	4.0	4.0	5.5	
4	3.0	3.0	3.5	5.5

#### 4.4.4.6 Maintenance sampling hole

In applications with sampling holes that are difficult to access, a maintenance sampling hole can, if necessary, be made in the sampling pipe immediately after the detector housing. The maintenance sampling hole must be drilled with a hole diameter of 3.5 mm. The distance from the detector housing must be at least 0.5 m.

If required, the maintenance sampling hole can be made using the special “maintenance clip” (clip without drilling). See also Sec. 5.5.9.

Please note the following information:



#### Notices

When making a maintenance sampling hole, observe the following principles:

- A maintenance sampling hole should be made only if required, for example where normal sampling holes are difficult to access.
- A maintenance sampling hole is not included in the calculations set out in Sec. 4.4.4.3 and 4.4.4.4.
- The maintenance sampling hole is used only for maintenance purposes, to test the ASD 532 for alarming.
- In normal operation (no maintenance), the maintenance sampling hole must be sealed off with adhesive tape or a “maintenance clip” if available.
- All commissioning work on the airflow monitoring (initial reset) must be carried out with the maintenance sampling hole sealed off.

## 4.5 Equipment monitoring

### 4.5.1 Equipment monitoring applications

Equipment monitoring applications using the ASD 532 are additional monitoring applications to space surveillance. Equipment monitoring directly involves monitoring an object (machine, device or equipment). The ASD 532 is capable of monitoring the following objects:

- Electrics cabinets with or without forced ventilation
- EDP computer systems and cabinets with or without ventilation
- Devices and machines in production technology
- Transmitting installations / transmission facilities
- Vacuum cupboards in the chemical industry (air recirculation), subject to prior consultation with the manufacturer.

4.5.2 Principles of equipment monitoring



Notices

Equipment monitoring is subject to the following principles:

- The country-specific application guidelines must always be adhered to.
- In equipment monitoring it preferable to use Classes A and B compliant with EN 54-20.
- Equipment monitoring applications using the ASD 532 are additional monitoring applications to space surveillance.
- Planning with **the “ASD PipeFlow” calculation software is preferable**. This guarantees optimal detection behaviour and ensures that the technical system limits are optimally utilised. If for any reason the calculation with “ASD PipeFlow” is not possible, the thresholds as set out in Sec. 4.5.4 must be observed.
- Symmetry is not required for equipment monitoring.
- Unlike space monitoring, which involves individual sampling holes, equipment monitoring involves the use of **sampling fixtures** with several sampling holes.
- The **sampling fixture** is defined as a small pipe entity in the shape of an „I“, „U“, „T“, „H“ or other form with typically 2 to 4 sampling holes.
- The sampling fixtures are arranged in such a way relative to the object that they intake the air outflow (ventilation slot or screen). Ideally the sampling holes are distributed symmetrically on each sampling fixture over the surface of the opening / screen.
- On objects with a high air-flow rate (strong ventilation), the sampling holes can be fitted with SF ABS sampling funnels for optimal smoke detection.
- The systems should be formed in such a way that false alarms are avoided.

4.5.3 Examples of sampling pipe layouts for equipment monitoring

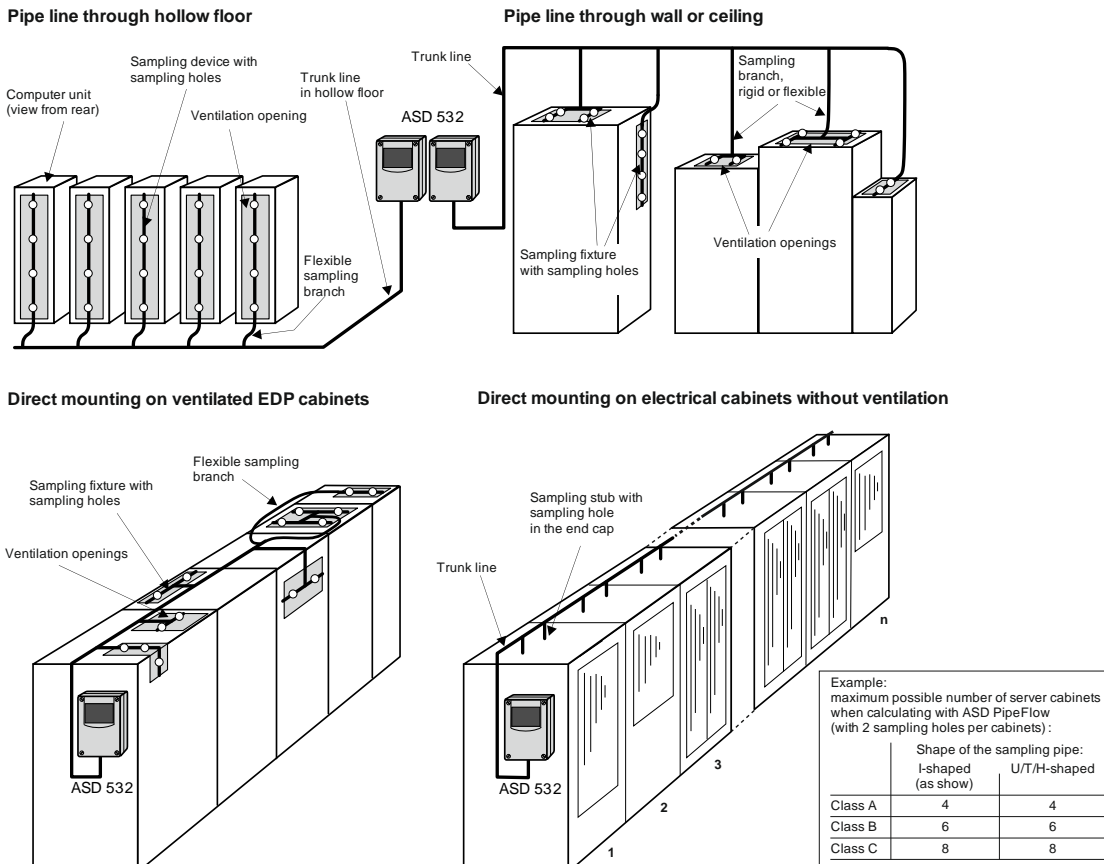

Fig. 11 Equipment monitoring layout variants (examples)

#### 4.5.4 System limits for equipment monitoring without “ASD PipeFlow” calculation

If it is unavoidable that a project is planned without “ASD PipeFlow” calculation (e.g. system modernisations), the following threshold values must be observed for each pipe input / smoke sensor:

Farthest sampling point	60 m
Minimum length of the sampling pipe	1 m
Maximum length of the sampling pipe (total)	80 m
Tube Ø trunk line (inner/outer)	20 / 25 mm
Minimum tube Ø of flexible sampling branch (inner/outer)	16 / 21 mm
Maximum length per flexible sampling branch	3 m
Number of sampling holes per sampling fixture	2 – 4
Minimum number of sampling holes	4
Maximum number of sampling holes (total)	16



#### Notice

The values in the table above must be strictly observed. Other values may be used only after consulting with the manufacturer.

##### 4.5.4.1 Alarm thresholds for equipment monitoring using sampling fixtures without “ASD PipeFlow” calculation

When planning without “ASD PipeFlow” calculation as described in Sec. 4.5.4, the following alarm thresholds (saved on switch positions **X01**, **X02** or **X03**) are to be set by means of the “ASD Config” configuration software based on the total number of sampling holes in **all sampling fixtures (AV)** on the ASD:

When using without duster filter unit FBL/DFU:

Response grade	Alarm threshold (%/m) for total number of sampling holes ( <u>without</u> FBL/DFU)			
	4 (1 AV)	5 – 8 (2 AV)	9 – 12 (3 AV)	13 – 16 (4 AV)
acc. to EN 54-20, class A	0.1	0.05	0.033	0.024
acc. to EN 54-20, class B	0.29	0.14	0.095	0.07
acc. to EN 54-20, class C ①	1.67	0.83	0.55	0.4

① In equipment monitoring it preferable to use Classes A and B compliant with EN 54-20.

When using with duster filter unit FBL/DFU:

Response grade	Alarm threshold (%/m) for total number of sampling holes ( <u>with</u> FBL/DFU)			
	4 (1 AV)	5 – 8 (2 AV)	9 – 12 (3 AV)	13 – 16 (4 AV)
acc. to EN 54-20, class A	0.07	0.035	0.023	---
acc. to EN 54-20, class B	0.2	0.1	0.065	0.05
acc. to EN 54-20, class C ①	1.17	0.58	0.38	0.28

① In equipment monitoring it preferable to use Classes A and B compliant with EN 54-20.

### 4.5.5 Sampling fixtures and sampling holes in equipment monitoring

The size and number of sampling holes in a sampling fixture are based on the size of the object's ventilation slot. The following approximate values apply:

Size of the ventilation slot (length x width in cm)	Shape of the sampling fixture	Number of sampling holes	Hole diameter (mm)
< 20 x < 15	I-shaped	2	4.5
< 30 x < 15	I-shaped	3	4
< 40 x < 15	I- or T-shaped	4	3.5
< 80 x < 20	T-shaped	4	3.5
< 40 x < 40	U-shaped	4	3.5
> 40 x > 40	H-shaped	4	3.5

or according to  
"ASD PipeFlow"  
calculation



#### Notices

- The sampling fixtures and their sampling holes must be placed directly in front of the object's airflow.
- The sampling holes must be facing the outflowing air.
- On objects with a high air-flow rate (strong ventilation), the sampling holes should be fitted with SF ABS sampling funnels for optimal smoke detection.
- Symmetry is not required for the sampling fixture.

Below are the system limits for a **direct pipe conveyed** via electrical or server cabinets as shown in **Fig. 11**. Except for the following specified hole diameters in the upper part of the table (e.g. for system modernisations), the hole diameter and alarm threshold are to be specified by an "ASD PipeFlow" calculation:

Electrical cabinet monitoring (as in Fig. 11)	Shape of the sampling pipe	Number of sampling holes	Number of cabinets	Hole diameter (mm)
With internal partitions	I-shaped	12	6	4 x 3.5 4 x 4.0 4 x 4.5 (only class B and C possible)
acc. to EN 54-20, class A	"I" / "U" / "T" / "H" shaped	8	4	Calculation with "ASD PipeFlow"
acc. to EN 54-20, class B	"I" / "U" / "T" / "H" shaped	12	6	
acc. to EN 54-20, class C	"I" / "U" / "T" / "H" shaped	16	8	

## 4.6 Monitoring air-conditioning and ventilation ducts compliant with EN 54-27

For monitoring closed air-conditioning and ventilation ducts compliant with EN 54-27, the sampling pipe is installed directly in the duct and fastened to the two duct walls by means of a DF 25 ventilation duct flange. To ensure lasting functionality of the aspirating smoke detector in this application, it is obligatory that air recirculation from the aspirating smoke detector into the duct is implemented.



### Notices

- The applicable standards and directives must be observed (e.g. DIN VDE 0833-2 and VdS 2095) when arranging the sampling pipes (location) in the air-conditioning and ventilation ducts.
- Area of application: 0 to 20 m/s, cross-section up to 4 m<sup>2</sup> (compliant with EN 54-27). After consulting with the manufacturer, channels with larger cross-sections larger than 4 m<sup>2</sup> (outside EN 54-27) or internal dimensions larger than 2.6 m can also be monitored.
- The “ASD PipeFlow” calculation software cannot be used for calculating the sampling pipe in air-conditioning and ventilation ducts.

The following points must be observed concerning **planning**, **installation** and **commissioning**:

- In so doing, the sampling pipe inside the duct must have the identical design for the sampling branch and blow-out branch (return conduit), i.e. the sampling holes of both branches are identical in number, size and orientation (facing the incoming airflow).
- The spacing to the first and last sampling holes must be 10 cm; the other sampling holes are uniformly spaced based on the channel inner measurement as shown in **Fig. 12**.
- Sampling branch and blow-out branch are to be positioned in the middle next to each other in the channel (10 cm spacing, defined by the DF 25 flange).
- All sampling holes have an identical diameter of 7.0 mm.
- The sampling holes are to be fitted with SF ABS sampling funnels.
- The sampling funnels are to be increased in diameter to 7.0 mm.
- The sampling holes must be directed against the incoming airflow.
- In principle, the position of the sampling branch and blow-out branch must be in the axis of the longer channel side, **Fig. 12 (A)**.
- If just before the monitoring location there is a ventilation slot, a channel feed or a bend, the minimum distance and the position of the sampling branch and blow-out branch must be selected accordingly, **Fig. 12 (B)**.
- The aspirating smoke detector must be operated with fan level III.
- The housing cover must be closed for the initial reset at commissioning (by means of [Config over Line](#), “ASD Config” via networking, or via external Ethernet cable; airtight compliant with the manufacturer's specifications).

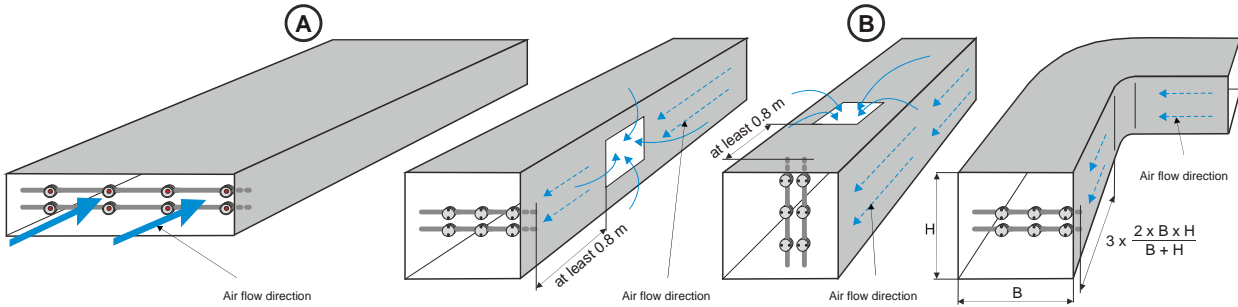
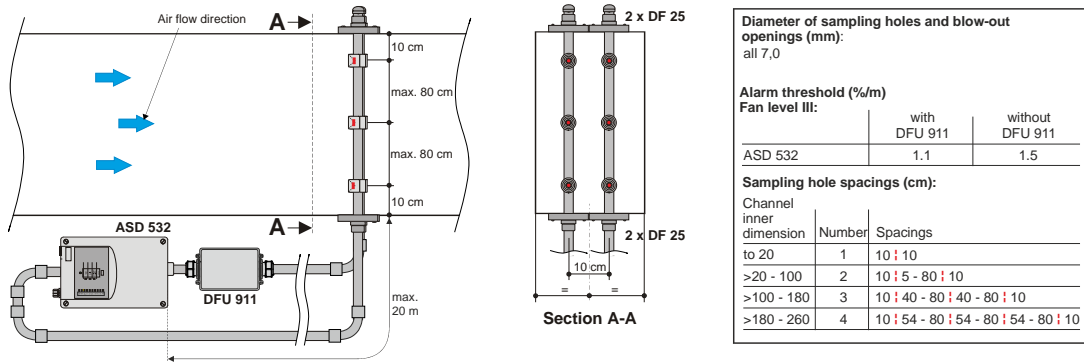

Fig. 12 Monitoring air-conditioning and ventilation direction ducts in compliance with EN 54-27

#### 4.7 Air recirculation

In applications where the sampling holes and the detector housing are in different climate zones, the sampled air has to be recirculated back to the climate zone of the sampling holes. It is imperative that the “ASD PipeFlow” calculation software is used to calculate the sampling pipe.

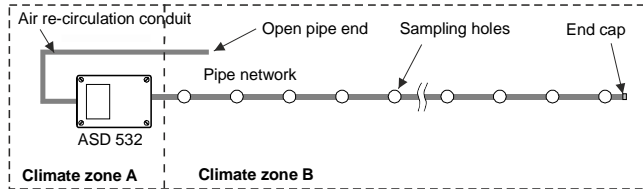

Fig. 13 Air recirculation for differing climate zones

## 4.8 Settings

Depending on the planning process – with or without the “ASD PipeFlow” calculation software – the following setting procedure is required:

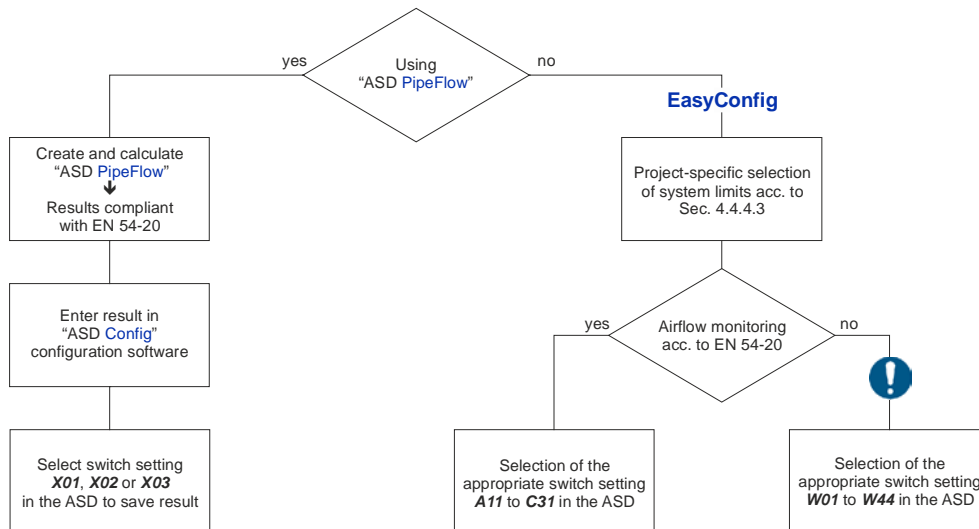

Fig. 14 Workflow for project-specific programming and adjustment



### Notice

Switch settings **W01** to **W44** may be used only after consulting with the manufacturer. The airflow monitoring values stored under those switch positions are **not** tested in accordance with EN.

The description of the predefined positions and the operator structure is found in Sec. 4.4.4.3, 4.4.4.4, 7.2.1 and 8.3.

Depending on the use of the ASD 532, it may be necessary to make adjustments to the airflow monitoring using the “ASD Config” configuration software. These adjustments relate merely to the size of the monitoring window (pipe breakage/ pipe blockage) and the fault delay time (time until the exceeded monitoring window is reported as a fault). Please note and adhere to the following information:



### Notices

- Increasing the **LS-Ü** values (**> ±20%** / **> 300 s**) means exceeding the normed EN 54-20 range and should be used only after consulting with the manufacturer.
- The **window size ±20%** should in principle **not be undershot**. Smaller window sizes may be set only if, at the same time, the delay time of the airflow monitoring is increased to at least **10 min**. Due to the very high sensitivity of the airflow monitoring when the window size is below ±20% and the delay time is ≤ 300 s, the risk of false alarms due to airflow monitoring faults increases accordingly.



### Notices

- In applications with high levels of air turbulence, it may be necessary in some instances to increase the delay time and the window size to over ±20%. **Important:** This means that norm EN 54-20 is no longer complied with and should only be used after consultation with the manufacturer.
- Changing the configuration “**Airflow pipe blockage / pipe breakage On/Off**” is for use under special conditions and may be implemented only after consulting with the manufacturer.

### 4.9 Electrical installation

#### 4.9.1 Installation cable requirements

The power supply line from the FACP to the detector housing is defined by the line and FACP technology in use.

Cables with twisted pairs are to be used as a matter of principle. With 4-wire and multi-wire cables, twin- or quad-twist cables are to be used.

Laying the voltage supply line and line in parallel is permitted.

A separate wire pair is to be used for the ASD 532 voltage supply.

The electrical installation is usually performed with commercially available cables. Depending on the country of use, special fire detector cable may be required by the relevant authorities. The relevant country-specific authorities should therefore be consulted concerning the required cable types.

The installation cable must have a minimum wire diameter of 0.8 mm (0.5 mm<sup>2</sup>). **Please refer to Sec. 4.9.2 for determining the exact maximum cable length and the required cable cross-section.**



#### Notices

- For safety reasons (EN 54) individual cables must be used for the outbound and return lines for addressable loop technologies.
- Further, the **manufacturer's specifications for the FACP** concerning maximum **line length**, **cable type**, **shielding** etc. of the addressable loop technology **must be observed**.
- The order separation and installation type are also subject to country-specific guidelines and regulations.
- **Caution, use compliant with UL:** For system monitoring – for terminals "Alarm" and "Fault", **do not use looped wire** under terminals. Break wire run to provide monitoring of connections.
- The electrical installation of the ASD 532 can normally be performed without screening. The installation of the SecuriFire / Integral addressable loop on an **XLM 35 / ML-SFD** must be **shielded**. Screening of the installation is required wherever EMC influences are to be expected. In the following environments disturbance variables can be expected and the installation must be provided with screening accordingly:
  - In and around transmitter and radio facilities. Near high-voltage and low-voltage installations with high energy. In areas with EMC field intensities in excess of 10 V/m In cable ducts and vertical shafts together with high-energy cables In areas with high-energy devices and installations (generators, power plants, railway facilities, X-ray equipment, etc.). Outside buildings.
- If screening is used, the cable screening in the ASD 532 is to be connected to an additional support terminal. The cable screening must **not** be connected to the minus or **ground** terminal of the AMB 32.



### 4.10 Restrictions



#### Notices

The following restrictions apply to the use and application of the ASD 532. For other solutions, please consult the manufacturer.

##### General information and space surveillance:

- The sampling holes of the tube network and the detector housing must be in the same climate zone (pressure/temperature zone) (sampled air may have to be recirculated to the other climate zone). Pressure differences between detector housing and sampling pipe (sampling holes) are not permitted.
- If sampling pipes with air at room temperature have to be routed through areas in which the temperature may drop below 4 °C, the tube parts in these areas may have to be specially installed (possibly by isolating the sampling pipe as specified by the manufacturer).
- Applications with a high level of dust and/or high atmospheric humidity require the use of accessory parts as recommended by the manufacturer, e.g.: dust filter unit, dirt trap box, water retaining box or manual ball valve for sporadic cleaning of the sampling pipe using compressed air (see also Sec. 11).
- The maximum pipe length specified must **not** be exceeded.
- Several rooms may only be monitored by one and the same aspirating smoke detector if so permitted by the relevant guideline (e.g. DIN VDE 0833-2, Germany; VKF, Switzerland).
- For space surveillance involving premises with a height of more than 16 m, the situation must first be clarified beforehand with the manufacturer, the insurance companies and, if necessary, the fire brigade (in some cases larger or higher monitoring areas are possible).
- In the event of an emergency the sampling holes must be accessible for cleaning (possibly by cleaning using compressed air from the detector housing or under 0°C with nitrogen).
- The fan creates a sound pressure level (possibly mount the detector housing in an acoustically insulated cabinet – e.g. ASD sound insulation housing – or ancillary room, see also Sec. 5.4).
- Special settings (larger airflow window, longer delay time etc.) may have to be made in areas with significant temperature fluctuations of more than 20°C at both the sampling pipe and on the detector housing.
- In spaces with high ambient temperatures of > 50°C and/or a humidity of > 80%, cooling sections may have to be used in the sampling pipe.
- Only those materials listed and approved by the manufacturer are to be used to create the system (component of the device approval according to EN 54-20). Materials from other sources may be used only if the manufacturer's written consent has been obtained.
- It is **not** permitted to monitor ex-zones with the ASD 532.
- The environmental influences as listed in Sec. 4.11 must be observed.

##### Equipment monitoring (additional):

See Sec. 4.5

### 4.11 Environmental influences

	<b>Notices</b>
<ul style="list-style-type: none"> <li>On the basis of the conducted tests, the ASD 532 may be used in an environment that is within the scope of the type approvals. The environmental conditions as described in Sec. 13 must also be observed. Non-observance can negatively impact proper functioning of the ASD 532.</li> <li>For special applications (e.g. in Arctic or tropical climates, in marine applications, high-level EMC environments, high shock impact, etc.) please contact the manufacturer of the ASD 532 for empirical values and special application guidelines.</li> </ul>	

### 4.12 Use compliant with UL 268 7<sup>th</sup> Ed, UL 268A 4<sup>th</sup> Ed and ULC-S529 4<sup>th</sup> Ed

For use compliant with **UL 268 7<sup>th</sup> Ed**, **UL 268A 4<sup>th</sup> Ed** and **ULC-S529 4<sup>th</sup> Ed** the following alarm sensitivity ranges of the used smoke sensors in the ASD 532 must be adhered to.

	<b>Notices</b>
<p>① All sampling holes in the tube network shall have a calculated sensitivity value and transport time according to the specifications in the following tables. The “ASD PipeFlow” must be used for the calculation.</p>	

#### 4.12.1 Use in USA according to UL 268 7<sup>th</sup> Ed and UL 268A 4<sup>th</sup> Ed

For use within the USA, the following information and the listed editions of the UL standards apply:

Special applications, according to UL 268 7 <sup>th</sup> Ed		
Sampling hole sensitivity range ①	0.02 – 0.3 %/m	0.0061 – 0.09 %/ft
Air velocity range	0 – 20 m/s	0 – 4000 ft/min
Maximum transport time ①	63 s	
Sampling holes / sampling tube configuration	as defined by “ASD PipeFlow” calculation software ①	
Open area protection, according to UL 268 7 <sup>th</sup> Ed		
Sampling hole sensitivity range ①	5.54 – 6.38 %/m	1.72 – 1.99 %/ft
Air velocity range	0 – 20 m/s	0 – 4000 ft/min
Maximum transport time ①	7 s	
Sampling holes / sampling tube configuration	as defined by “ASD PipeFlow” calculation software ①	
Duct applications, according to UL 268A 4 <sup>th</sup> Ed		
Sampling hole sensitivity range	1.63 – 4.16 %/m	0.5 – 1.29 %/ft
Air velocity range	1.5 – 20 m/s	300 – 4000 ft/min
Maximum transport time	5 s	
Sampling holes, system limits	as defined in this manufacturer document (see also Sec. 4.6)	

#### 4.12.2 Use in Canada according to ULC-S529 4<sup>th</sup> Ed

For use within Canada, the following information and the listed editions of the ULC standards apply:

Special applications, according to ULC-S529 4 <sup>th</sup> Ed		
Sampling hole sensitivity range ①	0.02 – 10 %/m	0.0061 – 3.16 %/ft
Air velocity range	0 – 20 m/s	0 – 4000 ft/min
Maximum transport time ①	47 s	
Sampling holes / sampling tube configuration	as defined by “ASD PipeFlow” calculation software ①	
Open area protection, according to ULC-S529 4 <sup>th</sup> Ed		
Sampling hole sensitivity range ①	1.63 – 7.53 %/m	0.5 – 2.36 %/ft
Air velocity range	0 – 20 m/s	0 – 4000 ft/min
Maximum transport time ①	47 s	
Sampling holes / sampling tube configuration	as defined by “ASD PipeFlow” calculation software ①	
Duct applications, according to ULC-S529 4 <sup>th</sup> Ed		
Sampling hole sensitivity range	1.63 – 6.0 %/m	0.5 – 1.87 %/ft
Air velocity range	1.5 – 20 m/s	300 – 4000 ft/min
Maximum transport time	5 s	
Sampling holes, system limits	as defined in this manufacturer document (see also Sec. 4.6)	

## 5 Mounting

### 5.1 Mounting guidelines



#### Notices

**Material and products;** only the following materials supplied, approved and listed by the manufacturer may be used to create the system:

- Detector housings, smoke sensors, additional modules;
- Tube materials and fittings for the sampling pipe, accessory materials, pipe clamps (according to T 131 194).

Materials from other sources do not conform to EN 54-20 approval and may only be used if the manufacturer's written consent has been obtained.

Installation materials such as cables, intermediate distributors and fastening materials are usually supplied by the customer.

**Tools for handling the detector housing:** The tools listed below are required for mounting and installation (sorted in the sequence in which they are used in this document):

- |  |                                       |
|--|---------------------------------------|
| • Opening the detector housing         | flat-blade screwdriver No. 5 (8 mm)   |
| • Removing the pipe plug               | flat-blade screwdriver No. 2 (4 mm)   |
| • Securing the detector housing        | Torx screwdriver T20                  |
| • Module holder for additional modules | Torx screwdriver T15                  |
| • Terminals                            | no. 1 flat-blade screwdriver (3.5 mm) |
| • Replacing printed AMB circuit boards | Torx screwdriver T10                  |
| • Replacing the aspirating fan unit    | Torx screwdriver T15                  |

### 5.2 Dimensioned drawing / drilling plan for the detector housing

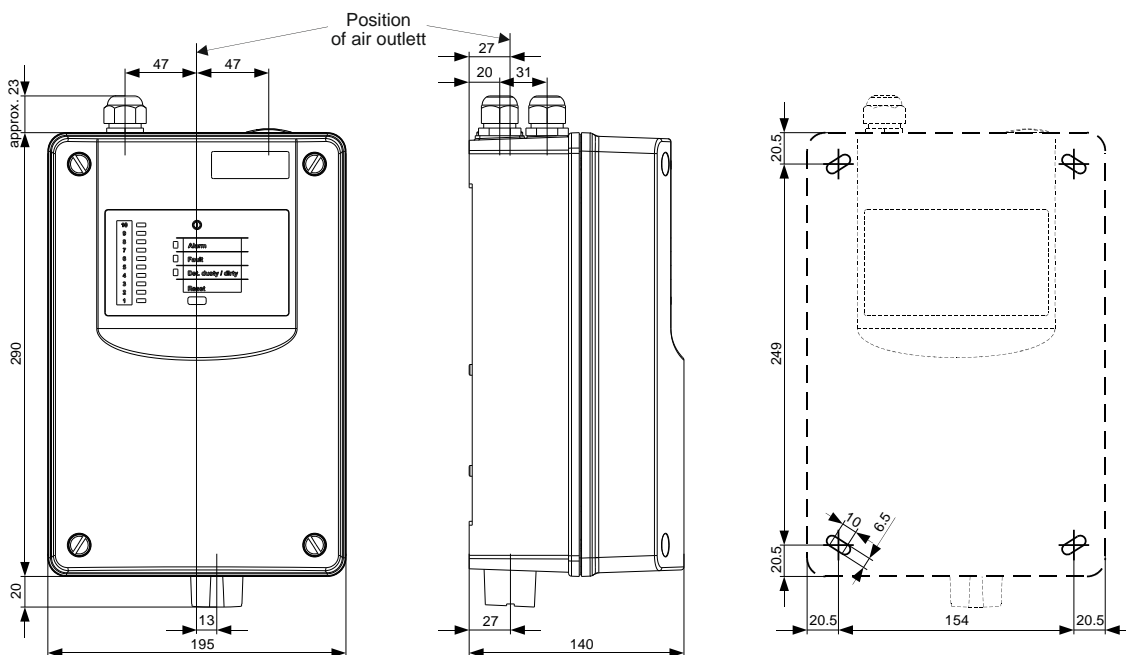

Fig. 15 Detector housing dimensioned drawing and drilling plan

### 5.3 Material for the sampling pipe



#### Notices

Tube materials and fittings must be rated at least as Class 1131 of norm **EN 61386-1**. Document **T 131 194** lists materials that meet this standard; it is part of the device approval of the ASD 532 according to EN 54-20.

Other materials do not conform to the EN 54-20 standard and may be used only if the manufacturer's written consent has been obtained and the following conditions are met.

- Compression resistance = min. 125 N (EN 61386-1)
- Shock resistance = min. 0.5 kg, fall height of 100 mm (EN 61386-1)
- Temperature range = min. -15°C to +60°C (EN 61386-1)
- Tube inner diameter = 19 to 22 mm
- Bending radius, bend = min. 30 mm.

The tube material is available in various plastics and metals. The individual plastic tube parts are usually glued. The flexible tube material for equipment monitoring is pluggable. The metal tubes are connected by means of press fittings.

The rigid plastic tubes can be shaped by heating. The tubes can be painted a different colour, although attention must be paid to the chemical compatibility between paint and tube.

The following materials are available:

Material	Connection
PVC (polyvinyl chloride, contains halogen)	Gluing
ABS (acrylonitrile-butadiene styrene, contains halogen)	Gluing
PA (polyamide, contains no halogen)	Plug-in connection
Copper	Press fitting
Stainless steel	Press fitting



#### Notices (see also Sec. 9.5.1)

- The two materials that use adhesives (PVC and ABS) must not be combined as different adhesives are used.
- Transitions from PVC or ABS to PA materials (flexible tube parts) are possible using special adhesive-screw junctions.
- As a material, PVC releases corrosive and toxic gases if burned or improperly disposed of. The use of PVC materials should therefore be restricted to wherever it is expressly permitted by the operator of the installation. In applications stipulated the use of halogen-free plastics, ABS or PA materials must be used for laying the sampling pipe. Country-specific guidelines and regulations must be observed.
- The adhesives and cleaning agents used for connecting PVC and ABS materials contain solvents and are combustible. For this reason, prior to working with these materials it is imperative to read and observe the safety instructions and information provided by the adhesive supplier.

A list of the available **materials for the sampling pipe** (pipes, fittings etc.) for the ASD 532 is available in a separate document (**T 131 194**).

### 5.4 Mounting the detector housing



#### Notices

- Mounting work on the detector housing is best carried out without the smoke sensors fitted.
- The smoke sensor is always installed in the detector box just when the ASD 532 is commissioned (see Sec. 6.3).
- Depending on the circumstances (e.g. long periods of time between mounting and commissioning or if the environment is extremely dusty (construction work), the housing cover should be kept closed until the device is commissioned.

The detector housing should always be kept in the room to be monitored. If this is not possible, ensure that the detector housing is located in a room that has the same air pressure or – in the case of air-conditioned rooms – the same climate and pressure zone. In applications where the sampling pipe and detector housing are mounted in different climate zones, a return sampling pipe to the monitored area is required. The return line can be adapted after removing the air outlet pipe plug on the ASD 532 housing. See also under Sec. 4.7, 5.4.2 and 5.4.3.

Special settings (larger airflow window, longer delay time etc.) may have to be made in areas with significant temperature fluctuations of more than 20°C at both the sampling pipe and on the detector housing. This also applies to temperature differences of more than 20°C between sampling pipe and detector housing.

An easily accessible installation location should be chosen so that the detector housing can be worked on without aids such as ladders and scaffolding. The ideal installation height for the detector housing is about 1.6 m above ground level (top edge of the detector housing).

On the entry side of the connection cable, a minimum distance of 10 cm to customer-side parts must be observed.

When positioning the detector housing, take into account the fact that the noise caused by the fan may in some cases be perceived as a disturbance. If no suitable location is available for the detector housing, it may be necessary to mount it in a sound insulated cabinet (e.g. ASD sound insulation housing). If air recirculation in the same climate zone as the sampling pipe is necessary, it can be implemented by means of a tube piece out of the acoustically insulated cabinet. The tube piece exiting from the sound insulated cabinet (transition) must be properly sealed. When using the ASD sound insulation housing, an M32 cable screw union is used for the transition. For further details about the ASD sound insulation housing contact the manufacturer.

## 5.4.1 Opening and closing the detector housing



### Notices about opening and closing

- To open the detector box, use a **flat-blade screwdriver no. 5** (8 mm). Smaller flat-blade screwdrivers may damage the material of the rotary snap locks.
- To actuate the **rotary snap locks**, **press** them **firmly** with the screwdriver towards the housing base and then **turn** through 90°. The position of the lock slit shows the current status (see **Fig. 16**):
  - ⇒ approx. 45° angled toward detector housing corner = closed;
  - ⇒ approx. 45° angled toward detector housing edge = open.
 In either position the rotary snap locks **must** snap into place.

#### Opening / closing

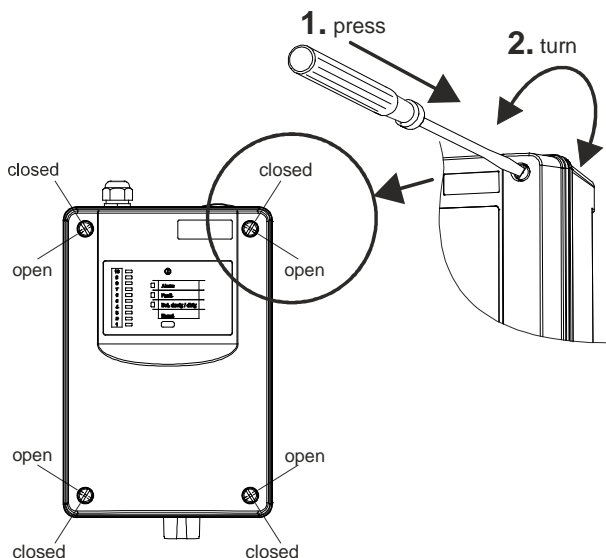

#### Locking

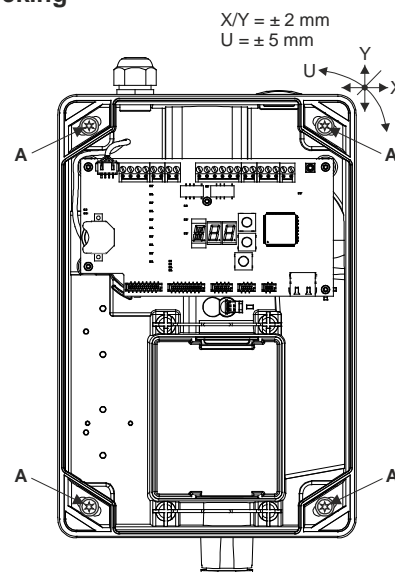

**Fig. 16** Open, closing and securing the detector housing

Once the detector housing is open, the four mounting holes in the housing base are accessible.

The detector housing is secured using the four supplied Torx wood screws ( $\varnothing$  4.5 x 35 mm) and the four U-washers ( $\varnothing$  4.3/12 x 1 mm) "A". Use a **Torx screwdriver T20** to insert and tighten the screws.

The positions of the fastening holes are shown in dimensioned drawing **Fig. 15**. When fastening to masonry, use the S6 dowels supplied.



### Notice

When mounting several ASD 532 units next to one another, make sure that the mounting holes are **drilled precisely**. The device can be shifted by a maximum of  $\pm 2$  mm horizontally and vertically to correct its mounting position. A rotation correction of approx.  $\pm 5$  mm is possible.

## 5.4.2 Mounting positions for the detector housing

In principle the detector housing can be mounted in the X, Y or Z axis. However, because of the labelling for the indicator elements, it is advisable to mount the device in the Y axis (vertical, control unit at the top). The sampling pipe is then inserted into the detector housing from below. This makes it easier to feed the tubes to accessory parts such as dust filter unit and water retaining box, which for physical reasons should always be below the ASD detector housing. If feeding the sampling pipe into the detector housing from above is unavoidable, the detector housing can also be rotated through 180° and then mounted (i.e. with the control unit at the bottom). To ensure that control unit labelling is not upside down, turn the control unit labelling strips accordingly (see Sec. 5.4.4).

To prevent the ingress of dirt, the detector housing ships fitted with the pipe plugs (tube network input). Likewise all the cable screw unions are sealed. If there is a return sampling pipe back to the monitored area, it can be connected directly to the detector housing in place of the air outlet pipe plug.

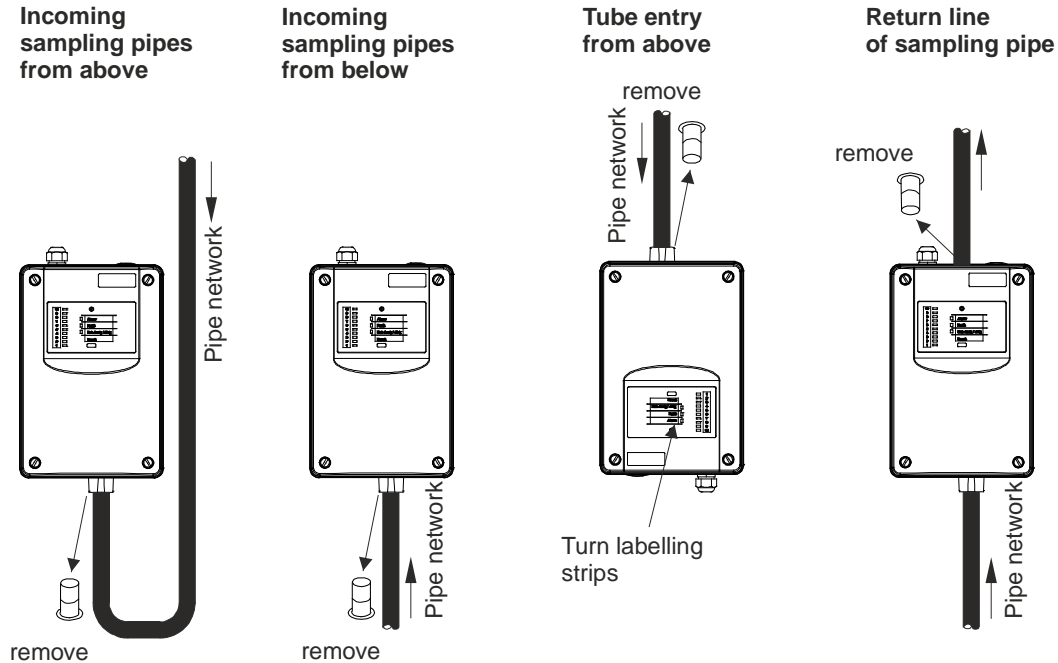

Fig. 17 Mounting position and pipe entries on the detector housing



### Notices about pipe entries

- The entry opening in the detector housing is designed so that the sampling pipe simply has to be plugged into place (conical opening). The sampling pipe should only be glued into place in exceptional circumstances and only after consulting with the manufacturer.
- The air outlet pipe plug (with openings) is to be fitted to the air outlet opening only.
- The pipe plugs must not be glued in the ASD housing (plug-in connector).

### 5.4.3 Removing the air outlet pipe plug

Insert the blade of a **flat-blade screwdriver no. 2** (4 mm) into one of the side recesses of the air outlet pipe plug. To release the pipe plug, prise gently toward the ASD housing.

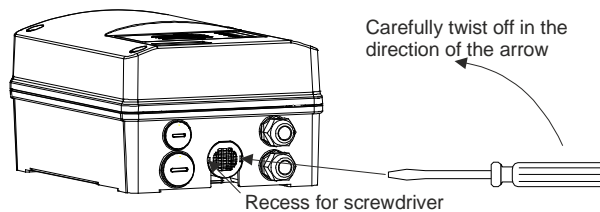

Fig. 18 Removing the air outlet pipe plug

### 5.4.4 Turning the labelling strip

Open the detector housing to turn the labelling strips.

The labelling strips can be pulled out of the cover by their tabs and after turning over inserted again into the holder.

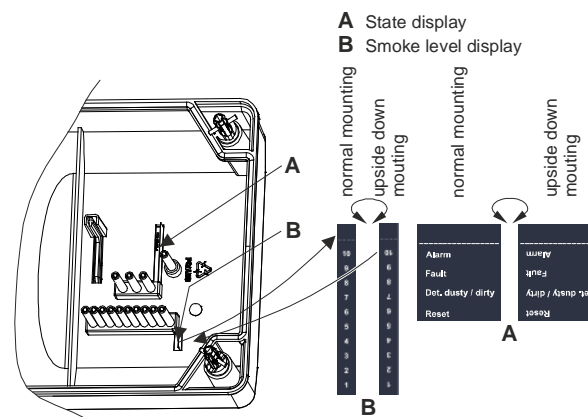

Fig. 19 Turning the labelling strips

### 5.5 Mounting the sampling pipe

#### 5.5.1 General

The mounting and installation are to be carried out by analogy as specified in Section "Planning" in this document. Any deviation from the layout of the sampling pipe and sampling holes (also outside the limits calculated using "ASD PipeFlow") is subject to the consent of the manufacturer.

The sampling pipe can be made of hard PVC or halogen-free ABS material, depending on requirements. In special applications – e.g. in extremely corrosive environments – other tube materials can also be used, subject to the specifications set out in Sec. 5.3.



#### Notice – installation and modification of the sampling pipe

System performance depends on the sampling pipe. Any extensions or modifications to the installation may cause functional faults. The effects of such changes must be checked. It is very important to adhere to the specifications in Sec. 4 (Planning). The "ASD PipeFlow" calculation software is available from the manufacturer.

#### 5.5.2 Mounting with PVC tubes and fittings

As a rule, if the system operator does not specify a halogen-free installation, the sampling pipe can be made using hard PVC tubing. When PVC tube material is installed, the individual tube parts are glued together using a special PVC adhesive (e.g. Tangit for PVC). The adhesive manufacturer's instructions must be followed. Before gluing, use household paper to remove any dust and grease deposits from the surfaces to be glued (do not use textile cloths). If the tube parts are very dirty, a cleaning agent as specified by the adhesive manufacturer may have to be used.



#### Notices

- The adhesives and cleaning agents used for connecting PVC materials contain solvents and are combustible. For this reason, prior to working with these materials it is imperative to read and observe the safety instructions and information provided by the adhesive supplier.
- The two glueable materials – ABS and PVC – must not be combined, since different adhesives are used.

#### 5.5.3 Mounting with ABS tubes and fittings

If required, halogen-free ABS material can be used for the sampling pipe. When ABS tube material is installed, the individual tube parts are glued together with a special ABS adhesive (e.g. Tangit for ABS). The adhesive manufacturer's instructions must be followed. Before gluing, use household paper to remove any dust and grease deposits from the surfaces to be glued (do not use textile cloths). If the tube parts are very dirty, a cleaning agent as specified by the adhesive manufacturer may have to be used.



#### Notices

- The adhesives and cleaning agents used for connecting ABS materials contain solvents and are combustible. For this reason, prior to working with these materials it is imperative to read and observe the safety instructions and information provided by the adhesive supplier.
- The two glueable materials – ABS and PVC – must not be combined, since different adhesives are used.

#### 5.5.4 Mounting with metal pipes and fittings

Metal tubes (copper, stainless steel) are connected using press fittings according to the manufacturer's instructions. For this purpose, commercially available radial pressing tongs (e.g. REMS radial pressing tongs) with the appropriate V pressing contours can be used.

#### 5.5.5 Linear expansion

Plastics have sizeable linear temperature expansion coefficient, which is why special attention should be given to the linear expansion (extension and contraction) of the sampling tube. An increase in temperature causes the tube to expand; a decrease in temperature causes it to contract. The importance of taking linear expansion into account increases as the temperature at the time of installation deviates from the usual operating temperature.

Linear expansion can be calculated as follows:

Calculation:  $\Delta L = L \times \Delta T \times \alpha$

$\Delta L$  = Linear expansion in mm  
 $L$  = Length in metres of the sampling pipe between two fixed points  
 $\Delta T$  = Temperature change in °C  
 $\alpha$  = Linear expansion coefficient in mm/m°C  
 for **PVC** = 0.08  
 for **ABS** = 0.10

Example: sampling pipe length 20 m, anticipated temperature change 10°C, material PVC:

Calculation:  $\Delta L = 20 \times 10 \times 0.08 = 16 \text{ mm}$



#### Notice

For straight layout the linear expansion can be up to **160 mm** over the total sampling pipe length (80 m) within the permitted temperature fluctuation range (20°C). It is therefore essential to ensure that the sampling pipe is able to "move" (slide) inside the pipe clamps. A distance of 200 mm (0.2 m) must therefore be maintained between the last pipe clamp and the end cap.

## 5.5.6 Mounting the sampling pipe



### Notice

When mounting the sampling pipe, make sure the points listed below are noted and observed (see Sec. 5.5.5):

- Pipe clamps at 1 m intervals are used to fasten the sampling pipe.
- The tubes must be cut to size using a pipe cutter. In doing so, ensure that the cut is at a right-angle to the tube axis. Remove any projecting burrs, **Fig. 20**.
- The ends of the individual tube pieces are to be bevelled slightly using a suitable tool, e.g. slightly bevel with a pipe scraper, **Fig. 20**.
- The individual tube sections are connected using fittings. Depending on the tube material used, use either the adhesive process described in Sec. 5.5.2 and 5.5.3 or the pressing process described in Sec. 5.5.4. The tubes are pushed into the fittings as far as the stop, **Fig. 21**.
- The connection points must be sealed tight to prevent the intake of any leakage air.
- If the sampling pipe or parts thereof is laid out vertically (e.g. in a riser or high-rack storage facility), make sure the tubes cannot slide down (secure pipe clamps directly below the fittings as shown in **Fig. 22**).
- The sampling pipe must be fastened so that the tube is able to “work” within the pipe clamp (linear expansion, see Sec. 5.5.5).
- A distance of at least 0.2 m must be maintained from the T-piece to the pipe clamp, starting from the branching points of the sampling pipe, **Fig. 23**.
- For changes of direction in the space surveillance, it is advisable to use 90° bends rather than 90° angles, **Fig. 23** (see also Sec. 4.4.2).
- For flush mounting or mounting in false ceilings, ensure that the tubes are not able to start oscillating by themselves.
- The exact definitive layout of the tubes – particularly in the case of flush mounting – must be documented precisely on the installation plans complete with dimensions.

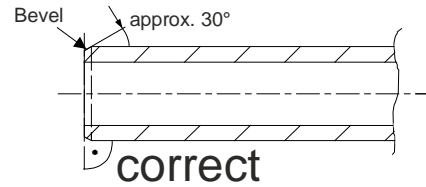
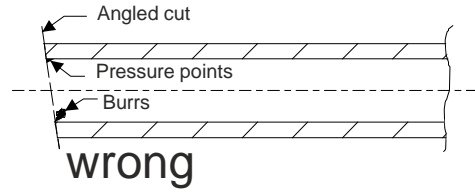

**Fig. 20 Cutting the tubes**

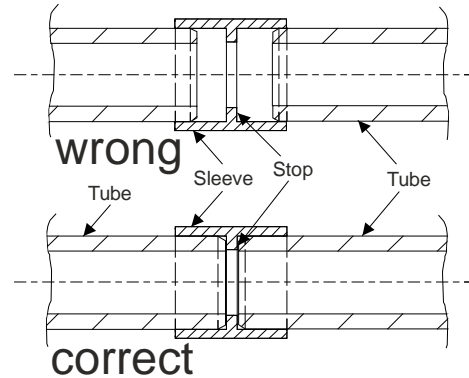

**Fig. 21 Assembling the tubes**

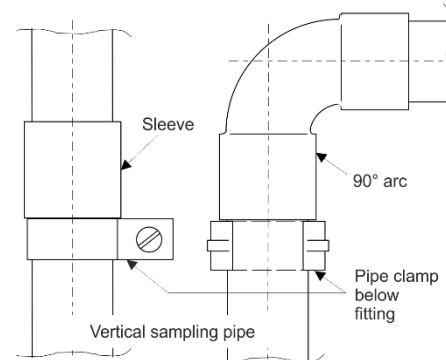

**Fig. 22 Vertical sampling pipe**

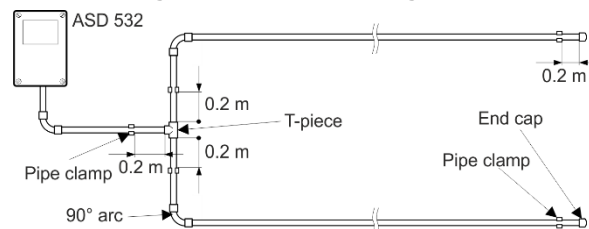

**Fig. 23 90° bend, branching point**

### 5.5.7 Mounting for equipment monitoring

When mounting for equipment monitoring (EDP installations, electrical cabinets etc.), plastic tube materials are to be used in principle. The same guidelines as described in Sec. 5.5.6 apply.

Equipment monitoring involves monitoring all the air outlet openings of the monitored devices.

Whenever possible, the sampling pipe and detector housing are always secured directly to the object to be monitored.

#### 5.5.7.1 Screw-free fastening of the sampling pipe

Use the click-on pipe clamps to secure the sampling pipe parts (sampling fixtures) without screws. This allows the sampling fixture or sampling pipe to be removed quickly during maintenance work on the monitored objects.

The click-on pipe clamps are screwed onto the support rails by means of threaded plates.

The support rails are best fastened at right angles to the tube axis to ensure a precise positioning of the sampling pipe (sampling fixture).

Double-sided adhesive tape is used to secure the support rails in the desired position on the object, **Fig. 24**.

Before using the double-sided adhesive tape, make sure the adhesion surfaces are cleaned with a **non-aggressive** cleaning agent (e.g. soap suds or similar).

Cable ties can also be used for securing purposes instead of the double-sided adhesive tape.

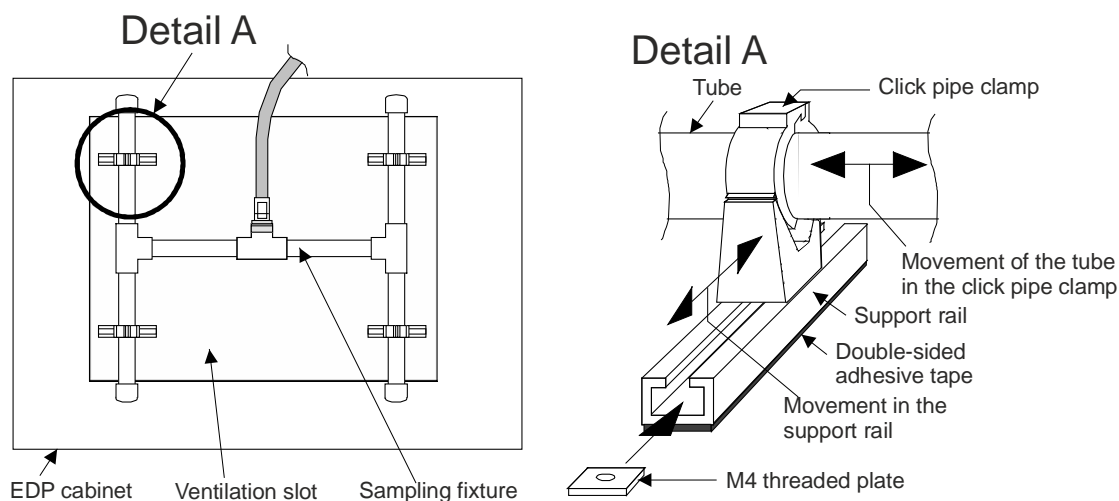

**Fig. 24 Screw-free fastening of a sampling fixture**

### 5.5.7.2 Transition to a flexible tube

With equipment monitoring, the transition from rigid to flexible tube can be made in principle using any type of fitting. The parts shown in **Fig. 25** are used for that purpose.

For a rigid sampling pipe made of **PVC** a **PVC threaded ring** with M20 internal thread is glued into the exit side of the fitting. The M20 quick-release coupling is screwed into the adapter for the flexible tube.

If the rigid sampling pipe is made of **halogen-free ABS**, the procedure is identical to that for PVC. Instead of the PVC threaded ring, however, a suitable **threaded ring made of ABS** is used.

The flexible tube is simply snapped into the quick-release coupling and snapped out of it again just as easily for maintenance work.



#### Notices

- Make sure the interfaces of the flexible tube are implemented “cleanly” so that the sealing ring in the quick-release coupling is not damaged.
- When clicking the flexible tube into place, make sure the tube and the quick-release coupling are pressed firmly against each other to prevent the intake of any leakage air.

For transitions from flexible tubes to sampling fixtures, proceed in the reverse order described above.

#### Transition from PVC or ABS fittings to flexible tube

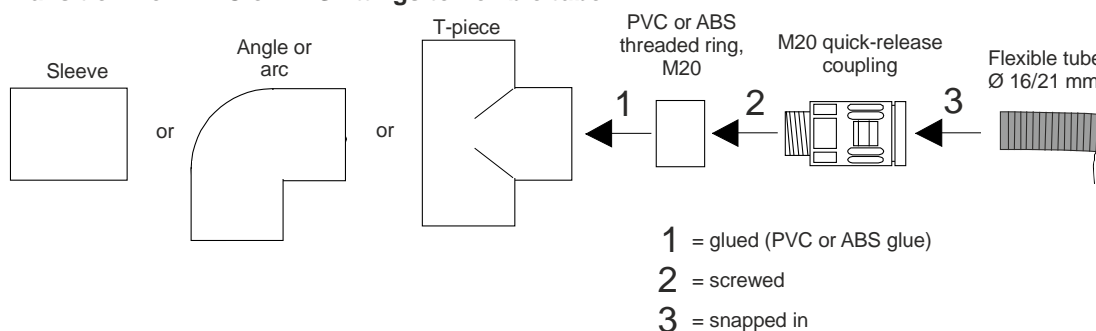

**Fig. 25 Transition from fittings to flexible tube**

### 5.5.8 Creating the sampling holes

The hole diameters for the sampling holes have to be determined and created by the customer as described in Sec. 4.4.4.4 and according to the specifications of the “ASD PipeFlow” calculation software or according to Sec. 4.5.5.

The sampling holes must be drilled cleanly so that no burrs or pressure points result. Use “new” drills with correctly ground surfaces (Fig. 26).

Whistling noises are a sign that the holes have not been neatly drilled. If so, the holes should be re-drilled and/or deburred.

For space surveillance, the sequence of hole diameters set out in Sec. 4.4.4.4 and the specifications of the “ASD PipeFlow” calculation software must be observed strictly.

If required, the sampling holes can be made using the special “sampling hole clips” (see 5.5.9).

For equipment monitoring, the sampling holes are drilled in the sampling fixture. The sampling holes are drilled into the sampling fixture in the direction of the air outlet from the object to be monitored. If required, these sampling holes can be fitted with sampling funnels (Sec. 5.5.10).

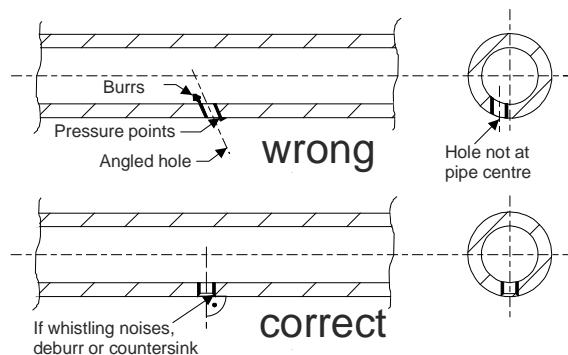

Fig. 26 Creating the sampling holes

### 5.5.9 Mounting the sampling hole clips and maintenance clips

#### Possible only with plastic tubes (PVC/ABS)!

At each required position in the sampling pipe drill a hole 8.5 mm in diameter (uniform Ø). The holes are made at right angles, in the centre of the pipe axis (as shown in Fig. 26).

The sampling hole clips are available in various sizes (Ø 2.0 / 2.5 / 3.0 / 3.5 / 4.0 / 4.5 / 5.0 / 5.5 / 6.0 / 6.5 / 7.0 mm). To determine the required sampling hole clips, refer to Sec. 4.4.4.4 and the specifications of the “ASD PipeFlow” calculation software or Sec. 4.5.5.

The sampling hole clips and the maintenance clips are clipped onto the sampling tube so they snap into the 8.5 mm borehole, Fig. 27.

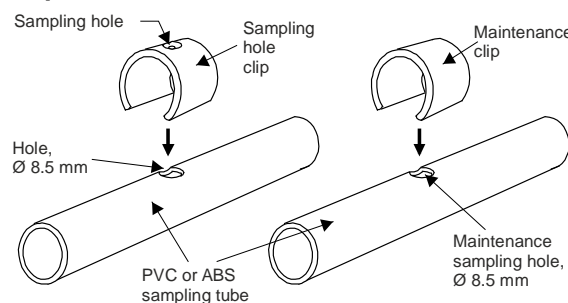

Fig. 27 Mounting clips

### 5.5.10 Mounting the sampling funnel

#### Possible only with plastic tubes (PVC/ABS)!

For equipment monitoring objects with a high air-flow rate (strong ventilation), the sampling holes can be fitted with funnels for optimal smoke detection.

If forced ventilation is used in rooms and/or on equipment, the use of sampling funnels is imperative.

The sampling funnels are secured to the tube of the sampling fixture and adjusted to the previously drilled sampling holes as described in 4.5.5 (see Fig. 28).

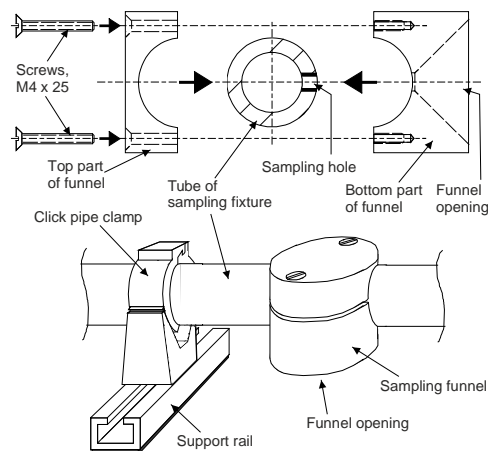

Fig. 28 Using sampling funnels

### 5.5.11 Mounting sampling stubs for a ceiling bushing

#### Possible only with plastic tubes (PVC/ABS)!

The parts required for a sampling stub for a ceiling bushing duct are shown in **Fig. 29**.

A T-piece is built into the sampling pipe at the required point.

The assembly sequence is carried out as indicated by the numbering **1 to 8**.

The sampling hole size (8) is selected based on the specification in Sec. 4.4.4.4 and/or the specifications of the “ASD Pipe-Flow” calculation software.



#### Notices

- Make sure the interfaces of the flexible tube are implemented “cleanly” so that the sealing ring in the quick-release coupling is not damaged.
- When clicking the flexible tube into place, make sure the tube and the quick-release coupling are pressed firmly against each other to prevent the intake of any leakage air.
- The maximum length of the flexible tube must not exceed **1.5 m**.

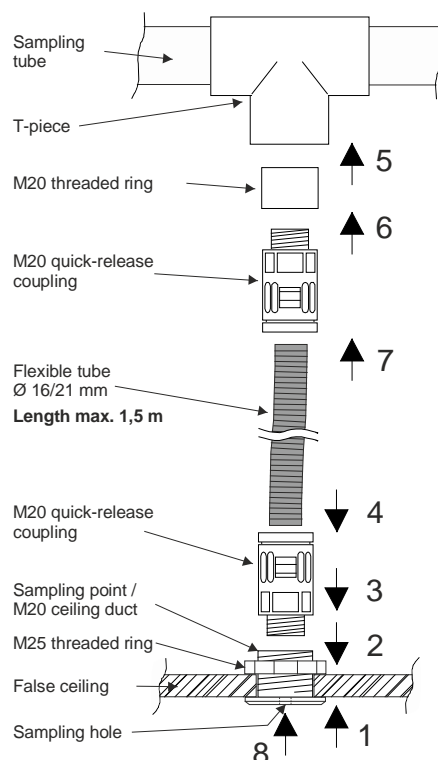

**Fig. 29** Mounting the ceiling bushing

### 5.5.12 Mounting the dust filter unit, dirt trap box, dust retaining box, water retaining box

Applications with extremely high levels of dust and/or dirt, extreme temperature ranges and/or atmospheric humidity outside the specified limit values require the use of accessory parts as instructed by the manufacturer, e.g.:

- Dust filter unit;
- Dirt trap box;
- Dust retaining box;
- Water retaining box;
- Manual ball valve for sporadic cleaning of the sampling pipe using compressed air;
- Automatic blow-out device

**Notices**

The following rules must be adhered to when using accessory parts:

- The use of a dust filter unit by itself is possible.
- The water retaining box, dust retaining box and dirt trap box should always be used in conjunction with a dust filter unit.
- An automatic blow-out device should be used in combination with a dust retaining box or a dirt trap box and a dust filter unit.
- Dust filter units, dirt trap boxes, dust retaining boxes and water retaining boxes must always be mounted below the detector housing. The water retaining box and dust retaining box must be located at the lowest point (water drain). The specified minimum dimensions (0.5 m) must be adhered to.
- The mounting positions for the water retaining box, dirt trap box and dust retaining box must be observed as indicated in **Fig. 30**.

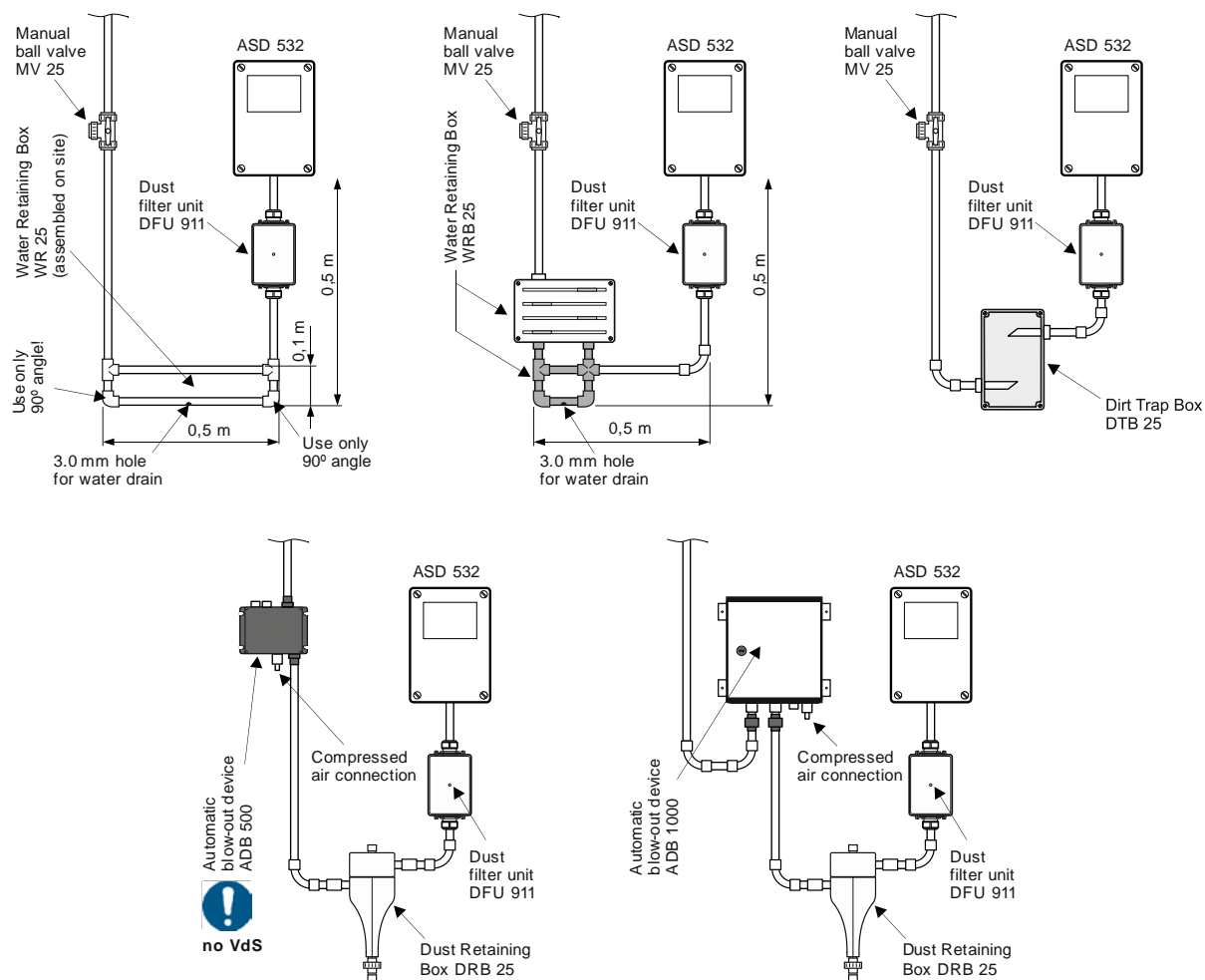

Fig. 30 Mounting accessory parts

# 6 Installation

## 6.1 Regulations



### Notices

- The electrical installation is to be carried out in accordance with the applicable country-specific regulations, standards and guidelines. Likewise, the local provisions must also be observed.
- Besides country-specific regulations and guidelines, the specifications concerning the requirements for installation cables and conductor cross-sections as described in Sec. 4.9 must be observed and implemented.

## 6.2 Cable entry



### Notice

Make sure the power is disconnected for all connection and wiring work on the ASD 532.

There are three M20 cable screw unions in the detector housing for feeding in the electrical installation. If needed, an additional one M25 cable screw union can be fitted in one reserve hole (blind plug).

The cable screw unions are suitable for cables with external diameters ranging between 5 and 12 mm (M20) or 9 and 18 mm (M25).



### Notices

- The device ships with the cable screw unions sealed with a dust-protection insert; remove the inserts before feeding in the cables. The dust-protection inserts merely prevent the ingress of any dust and/or dirt during the mounting of the device and do not provide any mechanical protection. Any cable screw unions that are not in use must be replaced with blind plugs (mounting set) to maintain the IP 54 protection class.
- **Use in compliance with UL 268:** When using the ASD 532 in compliance with UL 268, special 1/2" and 3/4" cable screw unions are to be used (customer-side). To be able to use them in the ASD housing, the existing M20 and M25 screw-junction pieces must be removed and replaced by 1/2" M20 adapters and 3/4" M25 adapters. The adapters are available from the manufacturer in the **AD US M-Inch** range of accessories.

### 6.3 Using the smoke sensor

The ASD 532 ships with the smoke sensor already fitted. It is application specific (according to required sensitivity range), purchased from the manufacturer and installed after the detector housing is mounted. See Sec. 1.8.



#### Notices when deploying smoke sensors

- Always leave the smoke sensor inside its protective packaging until just before it is to be installed in the detector housing.
- Depending on the situation (e.g. if there is a long time between mounting and commissioning or if the environment is very dusty due, for example, to construction), the smoke sensor should be installed just before commissioning the ASD 532.
- Before installing the smoke sensor check that the insect protection screens are properly fitted to the smoke sensor chamber at the air inlet and outlet.
- The smoke sensor chamber must be absolutely free of any dirt and/or dust. Remove any residue resulting from mounting the detector housing.

Check the installation position when installing the smoke sensor. The connector plug of the smoke sensor must be face away from the slots of the additional modules. The anti-twist rib on the smoke sensor case prevents an incorrect installation position.

The smoke sensor is secured inside the ASD housing using the two lock clamps. Connect the flat cable supplied with the smoke sensor to the smoke sensor (big flat cable connector) and to the AMB 32 main board (small flat cable connector).

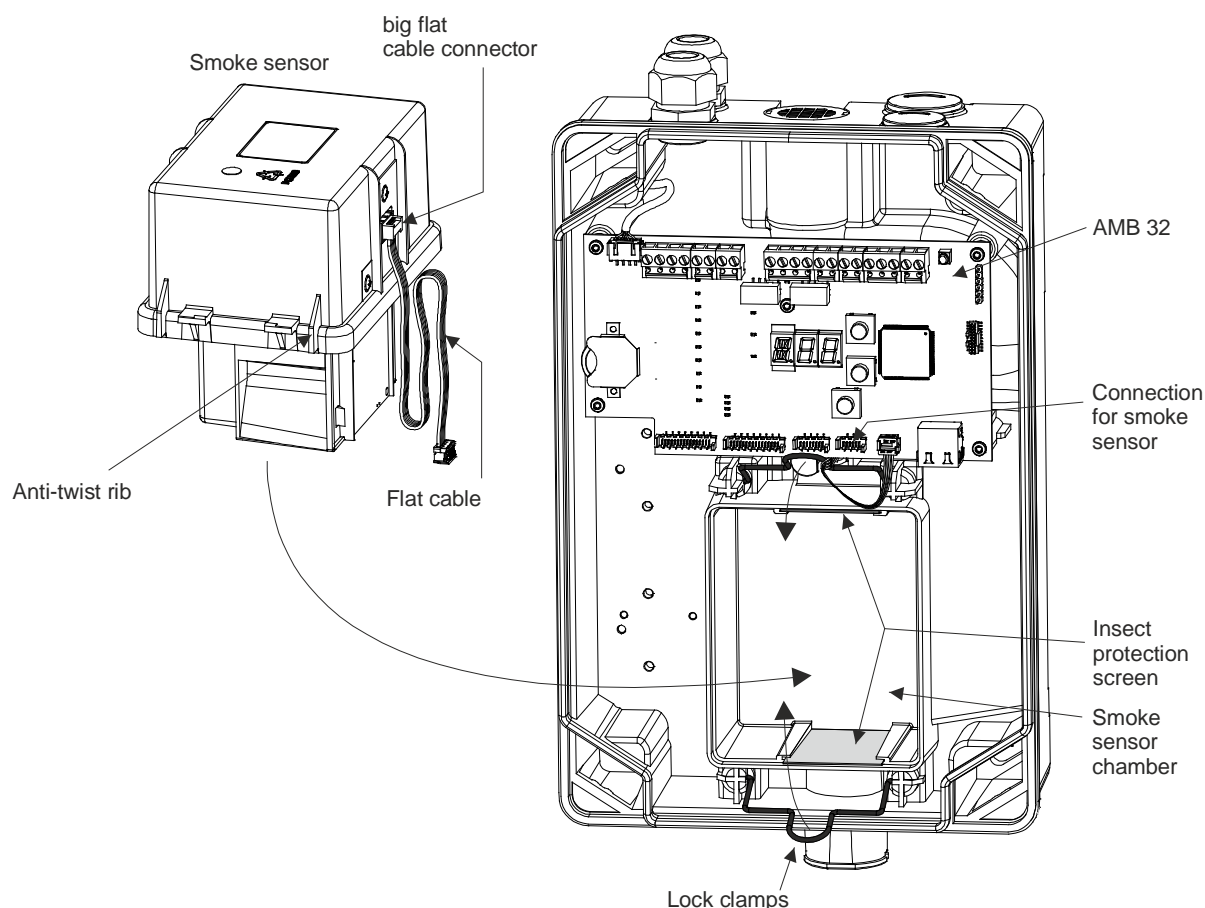
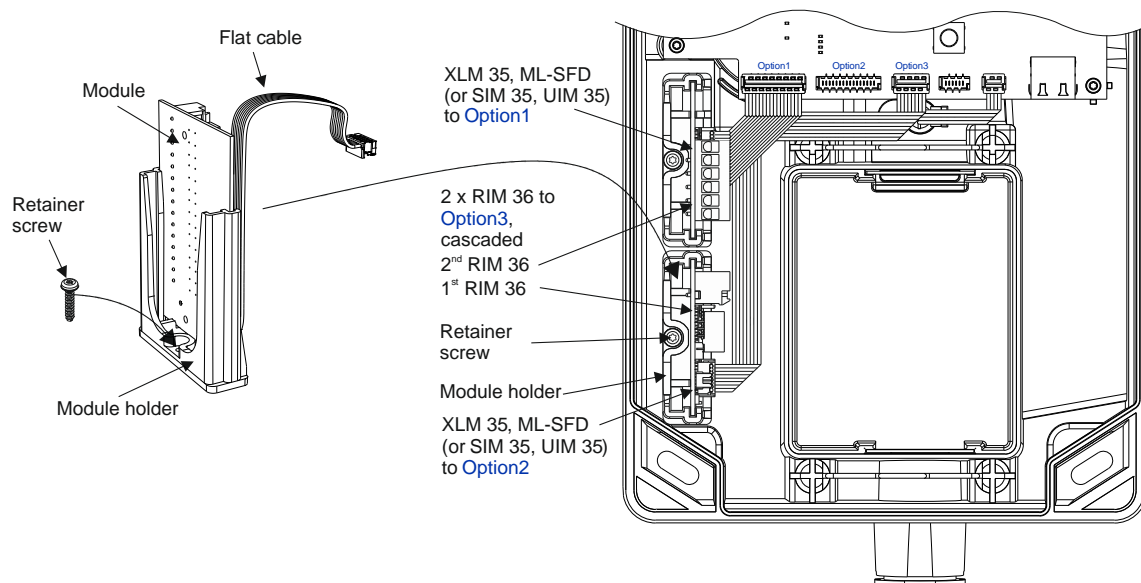

Fig. 31 Deploying the smoke sensors

## 6.4 Installing additional modules

There are two expansion slots for fitting the detector housing with optional additional modules. Given the modular assignment of flat cable connectors on the AMB 32 Main Board (see also Sec. 3.2, **Fig. 5**), it is recommended to observe the arrangement shown in **Fig. 32**.

The mounting set of each module comprises a module holder, mounting screw and the connecting cable (flat cable) for connecting to the AMB 32. Use a **Torx screwdriver T15** to tighten the mounting screw. The module can be removed from the module holder for mounting in the detector housing and for the subsequent electrical installation.



**Fig. 32** Installing additional modules



### Notice

The additional modules are automatically detected when the device is switched on, from which point on they are monitored and functional. To read out the SD memory card or when subsequently removing an additional module (e.g. because it is not being used), the additional modules must first be logged off via operation on the AMB 32 Main Board (o switch position, see Sec. 7.3.7).

The UMS 35 universal module holder is available for installing modules other than XLM, ML-SFD, RIM, SIM or UIM. It is secured in the detector housing instead of the module holders described above and requires both expansion slots. The UMS 35 consists of an angled sheet metal plate with various fastening options for additional modules.



### Notice, XLM 35, ML-SFD installation

With the installation of the use of an XLM 35 or ML-SFD, the ASD 532 meets the requirements in compliance with **EN 54-17** (short-circuit isolation). To ensure that the required identification is recognisable in compliance with EN 54-17, the supplied **identification sign** must be easily visible **outside** on the ASD housing and attached in the immediate vicinity of the ASD rating plate (same side) when the XLM 35 or ML-SFD is installed.

## 6.5 Electrical connection

The electrical connection is implemented by means of plug-in screw terminals. Use a **no. 1 flat-blade screwdriver** (3.5 mm) to tighten the screw terminals. Individual terminal blocks are fitted for the supply voltage, relay contacts, inputs, outputs, etc.



### Notices

- Inside the detector housing the lines should be fed to the terminals using the shortest possible route. Reserve loops via the main board are to be avoided (EMC).
- **Caution:** For system monitoring – for terminals “Alarm” and “Fault”, **do not use looped wire** under terminals. Break wire run to provide monitoring of connections.

### 6.5.1 Terminal assignment Main Board AMB 32

AMB terminal	Signal		Wiring
1	+14 to +30 VDC (UL/FM = 16.4 to 27)		Main power supply line from FACP or external according to <b>Fig. 33</b>
2	0 V		
3	+14 to +30 VDC (UL/FM = 16.4 to 27)		Redundant power supply line from FACP or external according to <b>Fig. 33</b>
4	0 V		
5	+ power supply		Connection of feedback signals according to <b>Fig. 40</b>
6	Output fault, OC (all fault events)		
7	Output Alarm, OC		
8	Rel. 1 (“NO”) ①	Fault	Connection of the line according to Fig. 37 to <b>Fig. 38</b> and specifications of the used line
9	Rel. 1 (“NC”)		
10	Rel. 1 “COM” ①		
11	Rel. 2 “NO”	Alarm	
12	Rel. 2 “NC”		
13	Rel. 2 “COM”		
14	External reset input + (opto-isolator input)		Connection according to <b>Fig. 34</b> and <b>Fig. 36</b>
15	External reset input – (opto-isolator input)		
16	OEM input + (opto-isolator input) ② ③		Connection similar to <b>Fig. 34</b> (see also Sec. 2.2.8)
17	OEM input - (opto-isolator input) ② ③		
18	PWR-O+	+ Power supply (+14 to 30 VDC)	Accessory bus
19	PWR-O-	– Power supply (GND)	
20	Data+	RS-485 connection	
21	Data-		



### Notices

- ① The “Fault” relay has picked up in the release state → contact Te. 10/8 closed, 10/9 open (ASD 532 under voltage; no fault event present).
- ② In some cases actuations via the OEM input may **not** comply with requirements **in accordance with EN 54-20** and may therefore only be used after consulting with the manufacturer.
- ③ The OEM input is **not** line monitored.

## Installation

### 6.5.2 Terminal assignment for Line module XLM 35 / ML-SFD

Terminal		Signal	Wiring
XLM	ML-SFD		
L1	P1	Data A	Addressable loop according to <b>Fig. 36</b> or <b>Fig. 39</b> (see also Sec. 8.5.5)
C1	N1	GND A	
G1	S1	Screen	
L2	P2	Data B	Addressable loop according to <b>Fig. 36</b> or <b>Fig. 39</b> (see also Sec. 8.5.5)
C2	N2	GND B	
G2	S2	Screen	

### 6.5.3 Terminal assignment for RIM 36 Relay Interface Module

RIM terminal	Signal ①		Wiring
1	Rel. 1	"NO"	Local info or connection to FACP input
2		"NC"	
3		"COM"	
4	Rel. 2	"NO"	
5		"NC"	
6		"COM"	
7	Rel. 3	"NO"	
8		"NC"	
9		"COM"	
10	Rel. 4	"NO"	
11		"NC"	
12		"COM"	
13	Rel. 5	"NO"	
14		"NC"	
15		"COM"	



#### Notice

① The assignment of individual or all relays can be changed with the "ASD Config" configuration software. If two RIM 36 devices are used, the relays of the second RIM 36 are not configured with any default criteria. The required programming must be performed using the "ASD Config" configuration software.

### 6.5.4 Terminal assignment of an SIM 35 Serial Interface Module

SIM terminal	Signal	Wiring / installation (see also Sec. 8.5.6)	
1	GND	Input	1 <sup>st</sup> conductor from wire pair 2
2	D +		1 <sup>st</sup> conductor from wire pair 1
3	D –		2 <sup>nd</sup> conductor from wire pair 1
4	GND	Output	1 <sup>st</sup> conductor from wire pair 2
5	D +		1 <sup>st</sup> conductor from wire pair 1
6	D –		2 <sup>nd</sup> conductor from wire pair 1

## 6.6 Connection variants



### Notice

The connection variants are determined by the possible line and FACP technologies used. For more information on connecting alarm transmitters, line monitoring elements, etc., please contact the manufacturer and/or supplier of the fire alarm system.

In all cases the ASD 532 must have an emergency power supply (country-specific, e.g. compliant with EN 54-4).

### 6.6.1 Power supply

The ASD 532 must always have an emergency power supply. Depending on the output current available at the fire alarm control panel (FACP) and the number of ASD 532 units to be connected, the power supply can be provided by the FACP; alternatively, an additional power supply must be provided locally.

The supply is via terminals 1 and 2. In applications which stipulate a redundant power supply line (country-specific), it is routed to terminals 3 and 4 (Fig. 33).



### Notices

- The supply inputs are not connected internally in the ASD and therefore cannot be used for direct forwarding to neighbouring systems.
- The terminals of the ASD 532 are designed for maximum 2.5 mm<sup>2</sup>. For forwarding the power supply line to a neighbouring ASD it may therefore be necessary to install additional distributor or support terminals.

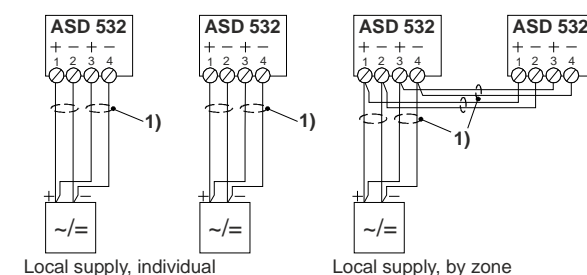
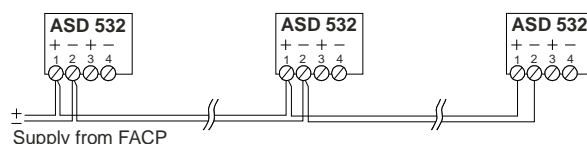

Local supply, individual

Local supply, by zone

1) redundant power supply line (optional, country-specific)

Fig. 33 Types of power supply



### Notice

To determine the required power supply and cable cross-section, the calculations set out in Sec. 4.9.2 must be carried out in all cases. For applications with redundant power supply, the calculations must be performed for both power supply lines individually.

### 6.6.2 Reset input

The reset input is potential-free (opto-isolator) and can be actuated on both the “plus” side and the “minus” side, Fig. 34. The input operates in the 5 to 30 VDC range and in an impulse bandwidth of 0.5 to 10 s. Thanks to the continuous current consumption of approx. 3 mA across the entire operating range, actuation can be carried out directly via an OC output.

If a continuous signal is imposed for longer than 20 s, the ASD 532 is switched inactive, the fault relay becomes active (triggers), and the fan is switched off. Once the continuous signal is switched off, the ASD is re-armed. Switching inactive via the “Reset external” input works only if the ASD 532 is not equipped with an XLM 35 or ML-SFD.

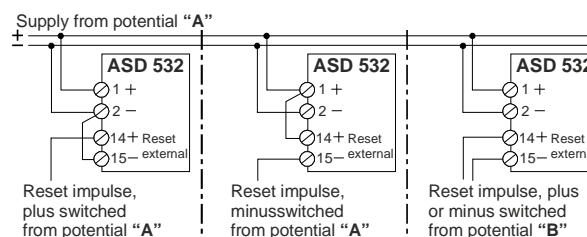

Fig. 34 Reset input

## 6.6.3 Control

The ASD 532 units connected to an FACP are controlled according to the detection zone mapping using the FACP states “Zone On/Off” and “Reset”. Two possibilities are available:

- Control via supply voltage (auxiliary relays in the ASD power supply line);
- Control via the “Reset external” input

### 6.6.3.1 Control via voltage supply by means of auxiliary relay

Depending on the location of the ASD power supply, the auxiliary relay may be placed in the FACP or directly in the ASD 532.

The auxiliary relay can be actuated in the following ways (see Fig. 35):

- line plus or minus
- SW output of the FACP
- SW output or function of a control module

The function types described above are determined by the FACP technology used; it is therefore essential to contact the manufacturer and/or the supplier of the FACP for details before implementing.

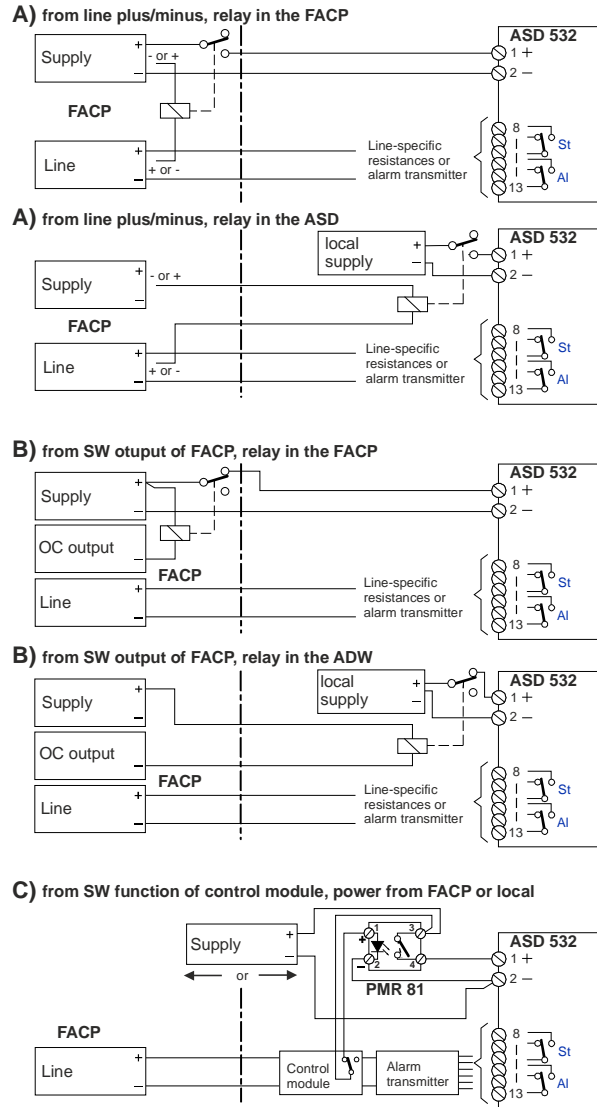

Fig. 35 Control via supply with relay



### Notices

- The EMC protective elements at the input of the ASD electronics cause a brief current peak (5 A / 1 ms) when the supply voltage is applied. When using auxiliary relays with a maximum contact rating of 1 A, this may lead to the relay contact sticking. For this reason auxiliary relays with a contact load of over **1 A** should **generally** be used, e.g. PMR 81 semi-conductor relay (see Fig. 35c)).
- The ASD supply path routed via the auxiliary relay contact must be short-circuit-proof or routed via a fuse component (circuit-breaker card).
- When using a PMR 81 semi-conductor relay, it may be necessary to invert the actuation signal (PMR only has a normally open (NO) contact function).
- To guarantee comprehensive emergency running properties, the connection must in all cases be implemented in such a way that if there is an FACP computer failure the ASD will continue to function (reset input not actuated).

6.6.3.2 Control via “Reset external” input

The following options are available for control via the reset input (see Fig. 36):

- A. Control via auxiliary relay from line plus
- B. Control via auxiliary relay or semi-conductor relay (PMR 81) from control output (open collector)
- C. Control without auxiliary relay, directly from control output (relay contact or open collector);
- D. Control via addressable loop when using the XLM 35 / ML-SFD. The control is then not by means of the reset input but rather directly with the corresponding command entry via the XLM 35 / ML-SFD on the ASD 532.

The function types described above are determined by the FACP technology used; it is therefore essential to contact the manufacturer and/or the supplier of the FACP for details before implementing.

!

### Notices

- When using a PMR 81 semi-conductor relay, it may be necessary to invert the actuation signal (PMR only has a normally open (NO) contact function).
- To guarantee comprehensive emergency running properties, the connection must **in all cases** be implemented in such a way that if there is an FACP computer failure the ASD will continue to function (reset input not actuated).
- Caution:** When control is via the “Reset external” input, the ASD 532 is supplied with voltage even if the zone (FACP) is switched off. For this reason the power supply line to the ASD must be disconnected to carry out any repair work (e.g. unplug terminals 1 and 2 on the ASD; also 3 and 4 in the case of a redundant supply).

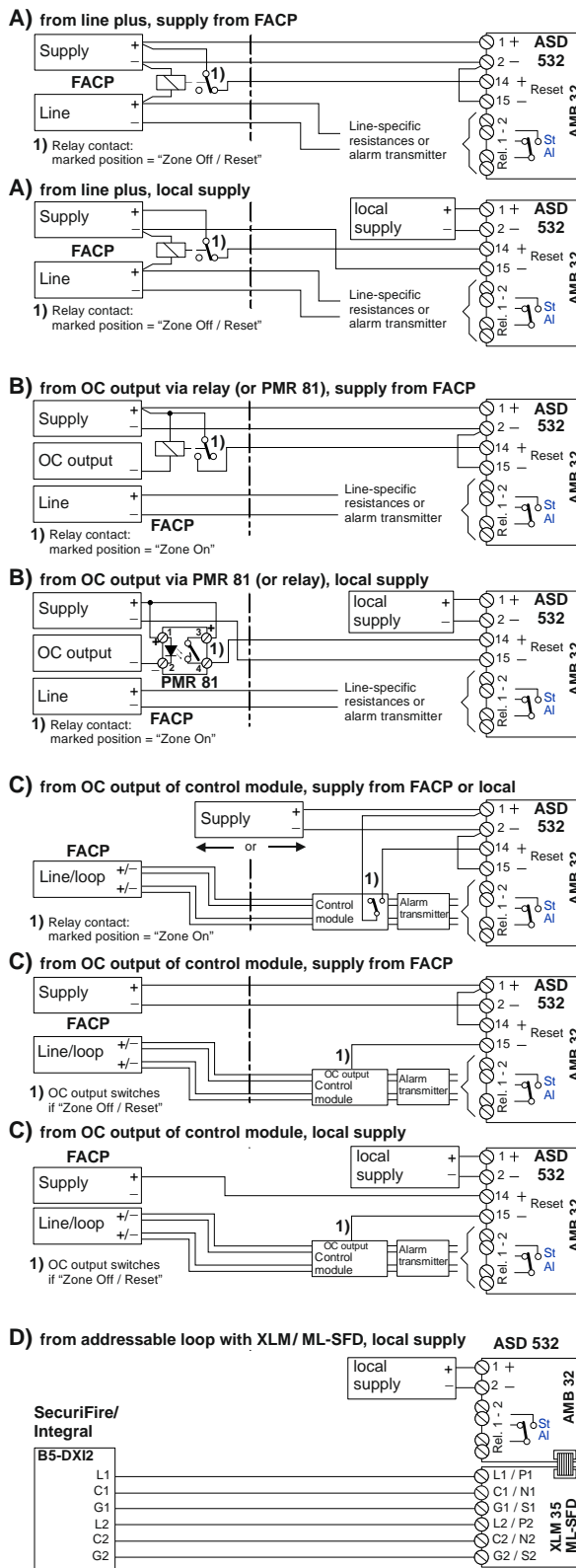

Fig. 36 Control via the “Reset external” input

## 6.6.4 Connection to the FACP line

Each of the following examples illustrates the control via reset input according to Sec. 6.6.3.2. If connection with the control via the voltage supply is required, the control circuit in the figures below can be implemented as described in Sec. 6.6.3.1.

### 6.6.4.1 Connection to zone detection via AI / St relays

For connection to zone detection lines, the control relay is usually actuated from the line plus. The precondition is that the line plus also switches for "Zone On/Off" and "Reset".

ASD 532, connected on one line

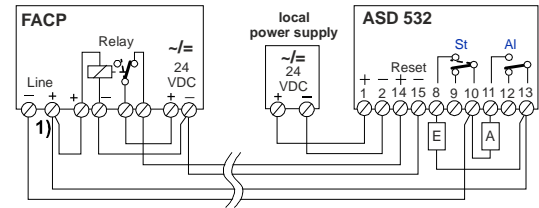
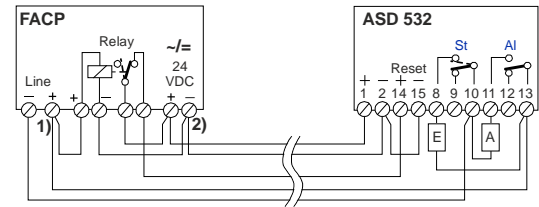

- 1) Output switches when: "Line/Zone A or B Reset"  
or: "Line/Zone A and B Off"
  - 2) from circuit breaker card if not short-circuit proof
- E = terminal resistor (only in the last ASD)  
A = alarm resistance

Fig. 37 Connection to zone detection

### 6.6.4.2 Connection to selective identification or addressable loop via AI / St relay

With line technologies such as selective identification lines and addressable loops, the control relay is actuated from a software-controlled output (output card or control module). The output is programmed via the FACP software using the "Zone Off" and "Reset" functions.

A normal relay or PMR 81 semi-conductor relay can be used as the control relay.

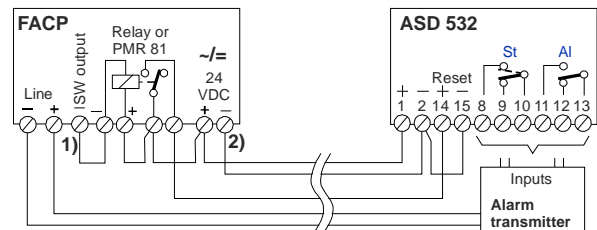

- 1) Output switches when "Zone Off" and "Reset"
- 2) from circuit-breaker card if not short-circuit proof

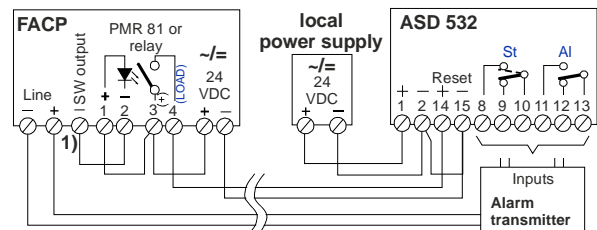

Fig. 38 Connection on selective identification or addressable loop

### 6.6.4.3 Connection to SecuriFire / Integral addressable loop from XLM 35 / ML-SFD

For the connection to SecuriFire/Integral addressable loop from the XLM 35 or ML-SFD no additional control relay is needed. Likewise the **AI** and **St** relays of the ASD 532 are not required. The state query and the control of the ASD 532 take place directly between the XLM 35 or ML-SFD and the addressable loop.

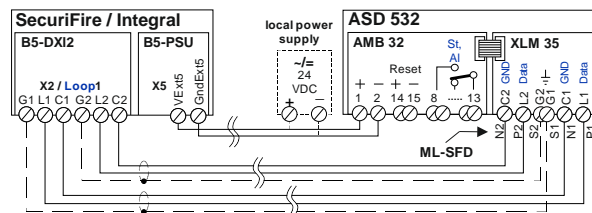

Fig. 39 Connection from XLM 35 / ML-SFD

Maximum connectible XLM 35 / ML-SFD units:

(see also notice below)

for each SecuriFire / Integral addressable loop (XLM 35) 32 units ①

for each SecuriFire / Integral addressable loop (ML-SFD) 28 units ①

① country-specific regulations and guidelines must be observed



### Notices

- The installation of the SecuriFire / Integral addressable loop must be shielded.
- The connection and line routing between **XLM 35 / ML-SFD** and the SecuriFire and Integral FACP is to be carried out in accordance with **Fig. 39** (L1 to L1, C1 to C1, etc.).
- The **identification sign** (EN 54-17) supplied with the XLM 35 or ML-SFD **must** be attached outside on the ASD (next to the ASD rating plate).

### 6.6.5 OC outputs

The ASD criteria “Alarm” and “Fault” (all fault events) are available as OC outputs.

Parallel and feedback indicators or other consumers (e.g. relays) can be connected to the OC outputs.

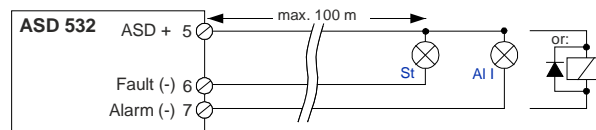

Fig. 40 Connecting the OC outputs



### Notices

- When connecting inductive consumers (e.g. relays), a free-wheeling diode is to be installed directly at the consumer (**Fig. 40**).
- The outputs are 0-volt switched and have a max. loading capacity of **100 mA** per output. The dielectrical strength per output is 30 VDC. The outputs are short-circuit-proof but not potential-free. Connection to the outputs affects the overall power consumption of the ASD 532.

## 7 Commissioning

### 7.1 General



#### Notices

The following points must be observed when commissioning the ASD 532:

- The ASD 532 is to be commissioned by trained and qualified personnel only.
- Prior to commissioning it is important to ensure that the entire sampling pipe has been laid correctly (junctions, sampling holes).
- If a maintenance sampling hole is provided as described in Sec. 4.4.4.6, it must be closed with adhesive tape or the maintenance clip.
- Prior to commissioning, an inspection of the mounting and installation must ensure that when the power supply is switched on there can be no damage to the ASD 532.
- Rewiring the device may be performed only when voltage is disconnected. Exception: Logging off additional modules XLM, ML-SFD, RIM, SIM, UIM (see Sec. 7.3.7).
- Before switching on, the smoke detector and any additional modules in the detector box must be fitted and connected to the AMB 32 main board by means of the supplied flat cable. See also Sec. 6.3 and 6.4.
- Before switching on the ASD power supply, ensure that all fire incident controls and remote alerting from the ASD 532 are blocked or deactivated.
- Immediately before switching on the ASD 532 for the first time, remove the isolating strip from the lithium battery (AMB 32).
- System performance depends on the sampling pipe. Any extensions or modifications to the installation may cause functional faults. The effects of such changes must be checked. It is very important to adhere to the specifications in Sec. 4 (Planning). The “ASD PipeFlow” calculation software is available from the manufacturer.

The detector housing has to be opened for commissioning the ASD 532 (see Sec. 5.4.1).

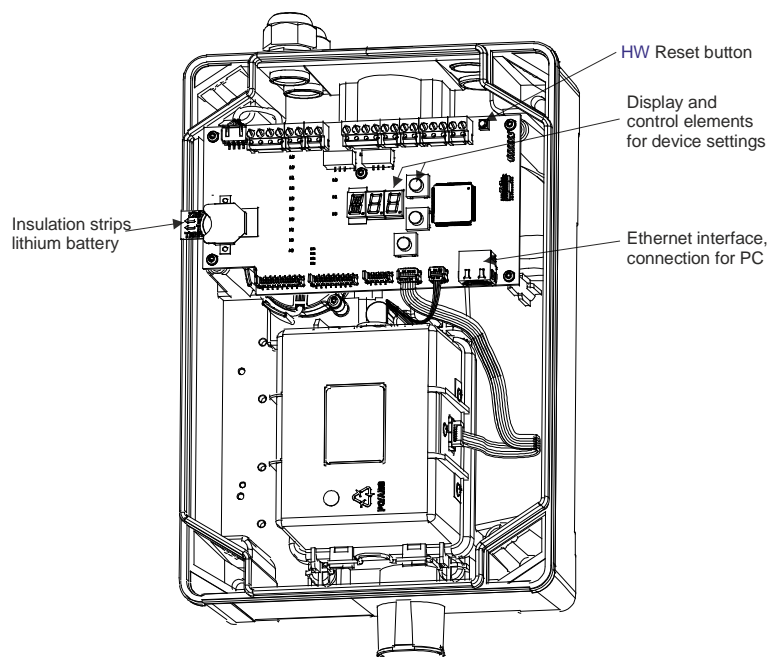

Fig. 41 Detector housing opened for commissioning

### 7.1.1 Connect ASD 532 via Ethernet with “ASD Config”

IP address **169.254.1.1** is programmed on every ASD 532 at the factory. No changes to the Ethernet settings of the PC are necessary if the IP address is obtained automatically.

A connection is established as follows:

1. connect PC and ASD 532 using an Ethernet cable (point to point), see also Sec. 7.1.1.1);
2. wait until the PC has assigned an IP address in the **169.254.x.x** range (this may take up to 1 min.) (see also Sec. 7.1.1.2);
3. establish a connection to the ASD 532 with “ASD Config” (see also Sec. 7.1.1.3).

If the ASD 532 is to be used in an existing network or if an IP address range outside **169.254.x.x** is wanted, refer to Sec. 7.1.1.1 to 7.1.1.3 for help. This also applies to problems when establishing connections.



#### Notice

It is the responsibility of the system operator and/or user of the special fire detector system to ensure IT security.

#### 7.1.1.1 Topology of the connection between ASD 532 and PC

For initial commissioning, the ASD 532 is connected point-to-point to the PC using an Ethernet cable.

If the ASD 532 is intended to function as part of an ASD network (see Sec. 11.4.2) or is to be integrated into an existing network, ensure that all participants have a unique IP address; this is because all ASD 532 units are pre-configured ex works with the same IP address

#### 7.1.1.2 Adjust configuration on the PC

In order for the PC to establish a connection to the ASD 532, it must be in the same subnet as the ASD 532. On an ASD 532 ex works, the PC settings must also be set to “Automatic”; the connection can then be established.

##### Configuration with automatic IP address

With administrator rights and the following work steps, the IP configuration can be set to “Automatic”:

1. via “**System control**” call up “**LAN connection**” (under “**Network and Internet**” or “**Network and enable centre**” > “**Change adapter settings**”) and open “**Properties**” by right clicking it;
2. mark the element “**Internet protocol version 4 (TCP/IPv4)**” and open “**Properties**”;
3. in the “**General**” tab, “**IP address**” and the “**DNS server address**” should be set to “**Obtain automatically**”;
4. in the “**Alternative configuration**” tab, “**Automatically assigned private IP address**” should be set.

##### Configuration with fixed IP address

If you want a fixed IP address, proceed as follows:

1. via “**System control**” call up “**LAN connection**” (under “**Network and Internet**” or “**Network and enable centre**” > “**Change adapter settings**”) and open “**Properties**” by right clicking it;
2. mark the element “**Internet protocol version 4 (TCP/IPv4)**” and open “**Properties**”;
3. in the “**General**” tab, the “**IP address**” should be set to the desired value or left unchanged;
4. the “**DNS server address**” is not necessary for operating the ASD 532; leave empty if uncertain.

### Configuration with temporary alternative IP address

If an IP address outside the range **169.254.x.x** is selected, connecting to the ASD 532 will no longer be possible. This is because the two participants are in different subnets. To solve this issue, an alternative IP configuration that allows access to the range **169.254.x.x** can be defined temporarily in the PC configuration. To do so proceed as follows:

1. via "**System control**" call up "**LAN connection**" (under "**Network and Internet**" or "**Network and enable centre**" > "**Change adapter settings**") and open "**Properties**" by right clicking it;
2. mark the element "**Internet protocol version 4 (TCP/IPv4)**" and open "**Properties**";
3. in the "**General**" tab via the "**Advanced...**" button call up the "**Advanced TCP/IP Settings**" dialogue;
4. open the "**TCP/IP address**" dialogue with the "**Add...**" button and enter the following configuration:
  - IP address: 169.254.1.2
  - Subnet mask: 255.255.0.0

Thanks to this alternative configuration the IP address of the ASD 532 can be changed without a temporary loss of connection. The alternative configuration can then of course be deleted once it is no longer needed.

#### 7.1.1.3 Adjust IP address on the ASD 532

If needed, any IP address can be assigned to the ASD 532 with the "ASD Config" configuration software. To do so, specify the IP address, subnet mask, and a requisite gateway in "ASD Config" via the menu item "**Connection**" > "**Edit address**".

The following IP addresses or ranges are excluded and detected by "ASD Config":

- 0.0.0.0/8
- 127.0.0.0/8
- 255.255.255.255

The same restrictions also apply to the gateway. The subnet is not subject to restrictions detected by "ASD Config".

**Important:** An address assignment **outside** the PC subnet results in a disconnection between "ASD Config" and the ASD 532. To re-establish the connection in the required address range, the network settings on the PC must be adjusted, or the alternative configuration described in Section 7.1.1.2 must be used.



#### Notice

If required, it is possible to reset the IP address to the factory setting **169.254.1.1** on the ASD 532 with **EasyConfig**, switch position **N** > **SE** > **FSE** (see Sec. 7.6.2).

## 7.2 Programming

The ASD 532 has several switch positions that are configured with permanently assigned parameters:

- normative system limits according to EN 54-20, Class A to C, switch positions **A11** to **C31**;
- Non-normative system limits, switch settings **W01** to **W44**;
- Configurable switch positions for saving the settings after using “ASD PipeFlow” and/or changing the device configuration using the configuration software “ASD Config” or SecuriFire or Integral-FACP (XLM 35, ML-SFD), **X01** to **X03**.

A detailed description of all switch positions is in Sec. 8.3.

If the ASD 532 is operated with **EasyConfig**, i.e. within the present system limits according to the tables in Sec. 4.4.4.3 and 4.4.4.4, then only switch settings **A11** to **C31** and **W01** to **W44** are to be selected; it is not necessary to use the “ASD Config” configuration software.

In systems where the sampling pipe planning was performed with the “ASD PipeFlow” calculation software, the response sensitivities of the smoke sensors calculated by “ASD PipeFlow” have to be programmed on the ASD 532 with “ASD Config”. The data is saved on the ASD 532 under one of the freely configurable switch positions **X01** to **X03**. The ASD 532 is then operated on the switch positions **X01** to **X03**.

The device ships with default values already stored under switch positions **X01** to **X03**. Specifically:

- position **X01** with position **A11**;
- position **X02** with position **b11**;
- position **X03** with position **C11**;

The following parameters can be modified using the “ASD Config” configuration software (see Sec. 7.2.1):

- Smoke sensor alarm thresholds;
- Trigger thresholds for dust and dirt (individually);
- Trigger thresholds for pre-signals 1, 2 and 3 (individually);
- Delay times for dust/dirt, pre-signal, alarm and fault (individually);
- Sensitivity and delay time of the airflow monitoring;
- Deactivate latching for dust/dirt, pre-signal, alarm and fault (individually);
- Deactivate criteria (pre-signals, dust/dirt, faults);
- Fan speed
- Date/time
- Autolearning (On/Off, duration);
- Day/night operation
- Relay assignment (RIM 36)

**Notice**

The parameters are configured ex factory with default states and values so that the triggering properties comply with EN 54-20. Changing the parameters may result in non-compliance with EN 54-20. Adjustments or modifications to the ASD 532 using “ASD Config” may be carried out only by the manufacturer or by persons under the supervision of and trained by the manufacturer.

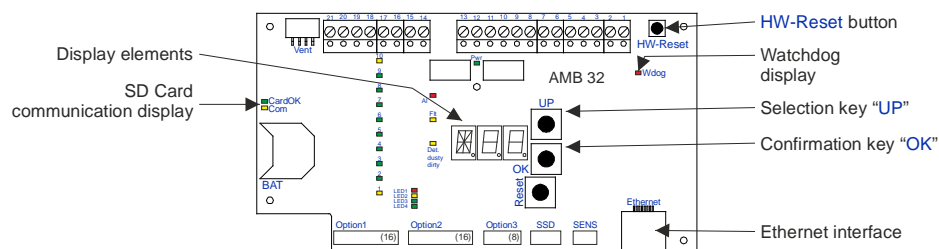

**Fig. 42 Control and displays elements on the AMB 32**

## 7.2.1 Configuration options

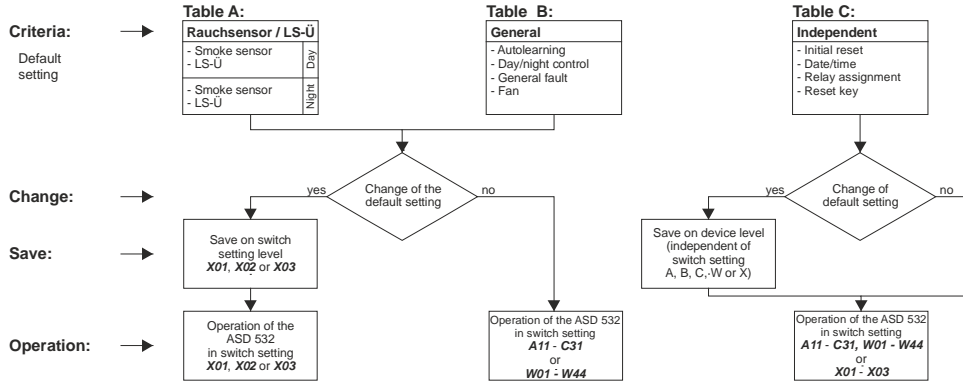

Fig. 43 Configuration overview

**Table A:** The criteria below are set separately for day/night control. Configuration changes are saved on one of the freely configurable switch positions **X01** to **X03**.

Sector	Default setting	Range	Resolution / levels	Saving after change
• Parameter				
<b>Alarm 2</b>				
• Alarm 2 On / Off	Off	Off / On		<b>X01 – X03</b>
• Sensitivity (always at least 20% above alarm)	1%/m	–10%/m	0.0002%/m	<b>X01 – X03</b>
• Alarm 2 delay	2 s	0 s – 60 s	1 s	<b>X01 – X03</b>
• Alarm 2 latching	On	On / Off		<b>X01 – X03</b>
• Holding time for area switchover (AI 2 to AI)	20	10 – 250	1 s	<b>X01 – X03</b>
<b>Alarm (EN 54-20)</b>				
• Alarm threshold (dependent on smoke sensor type and response class according to EN 54-20)	<b>C11</b>	0.02 – 10%/m 0.1 – 10%/m 0.5 – 10%/m	0.0002%/m	<b>X01 – X03</b>
• Smoke level value averaging (number)	4	1 – 10	1	<b>X01 – X03</b>
• Alarm delay (UL/ULC max. 30 s)	2 s	0 s – 60 s	1 s	<b>X01 – X03</b>
• Alarm cascading	Off	Off / On		<b>X01 – X03</b>
• Alarm latching	On	On / Off		<b>X01 – X03</b>
<b>Pre-signal</b>				
• Pre-signal 1 On / Off	On	On / Off		<b>X01 – X03</b>
• Pre-signal 2 On / Off	On	On / Off		<b>X01 – X03</b>
• Pre-signal 3 On / Off	On	On / Off		<b>X01 – X03</b>
• Pre-signal 1 (100% = alarm threshold)	30%	10 – 90%	10%	<b>X01 – X03</b>
• Pre-signal 2 (100% = alarm threshold)	50%	VS 1 + 10 – 90%	10%	<b>X01 – X03</b>
• Pre-signal 3 (100% = alarm threshold)	70%	VS 2 + 10 – 90%	10%	<b>X01 – X03</b>
• Pre-signal delay (VS 1 – VS 3)	2 s	0 s – 60 s	1 s	<b>X01 – X03</b>
• Pre-signal latching	Off	Off / On		<b>X01 – X03</b>
<b>Smoke sensor dust/dirt</b>				
• Smoke sensor dust On / Off	On	On / Off		<b>X01 – X03</b>
• Smoke sensor dirt On / Off	On	On / Off		<b>X01 – X03</b>
• Dust threshold (% of AI)	50%	5 – 60%	5%	<b>X01 – X03</b>
• Dirt threshold (% of AI)	75%	65 – 100%	5%	<b>X01 – X03</b>
• Dust latching	On	On / Off		<b>X01 – X03</b>
• Dirt latching	On	On / Off		<b>X01 – X03</b>
• Smoke sensor fault delay	30 s	0 s – 60 s	1 s	<b>X01 – X03</b>
<b>Airflow monitoring</b>				
• LS-Ü pipe blockage On / Off	On	On / Off		<b>X01 – X03</b>
• LS-Ü pipe breakage On / Off	On	On / Off		<b>X01 – X03</b>
• LS-Ü sensitivity (applies to A01 to C31) ①	±20% ①	±1 – ±70%	± 1%	<b>X01 – X03</b>
• LS-Ü value averaging (number)	20	1 – 30	1	<b>X01 – X03</b>
• LS-Ü delay (applies to A01 to C31) ①	300 s ①	10 s – 3,600 s	1 s	<b>X01 – X03</b>



### Notice

① Stored in switch positions **W01** to **W44** are increased values that are not tested for EN compliance (see Sec. 4.4.4.4).

**Table B:** The following criteria apply to the entire ASD 532. Configuration changes are stored in connection with the adjustments from Table A, likewise on one of the user configurable switch positions **X01** to **X03**.

Sector • Parameter	Default setting	Range	Resolution / levels	Saving after change
<b>Autolearning</b>				
• Autolearning On / Off	Off	On		<b>X01 – X03</b>
• Autolearning duration	3 days	1 min to 14 days	min, h, days	<b>X01 – X03</b>
• Autolearning factor (of measured AI threshold)	1.5	1.1 – 10 x		<b>X01 – X03</b>
<b>Day/night control &amp; weekday control</b>				
• Day/night control On / Off	Off	Off / clock / FACP / input "OEM"		<b>X01 – X03</b>
• Day start time (only with "Clock")	06:00	00:00 – 24:00	1 min	<b>X01 – X03</b>
• Night start time (only with "Clock")	20:00	00:00 – 24:00	1 min	<b>X01 – X03</b>
• Weekday control (only with "Clock")	On	Mon. to Sun.	days	<b>X01 – X03</b>
<b>General faults</b>				
• Lithium battery / clock fault	On	On / Off		<b>X01 – X03</b>
<b>Fan</b>				
• Fan speed	Level II	Level I to III	1	<b>X01 – X03</b>
<b>Deactivate sensor</b>				
• Smoke sensor	On	On / deactivated		<b>X01 – X03</b>

**Table C:** Independent configurations. These can be changed regardless of the switch position in the ASD 532.

Sector • Parameter	Default adjustment	Selection
<b>Clock</b>		
• Year, month, day, hour, minute	---	minutes – year
<b>Relay / OC output / reset key / various</b>		
• Relay 1, 1 <sup>st</sup> RIM 36	Pre-signal 1	acc. to Sec. 7.2.2
• Relay 2, 1 <sup>st</sup> RIM 36	Pre-signal 2	acc. to Sec. 7.2.2
• Relay 3, 1 <sup>st</sup> RIM 36	Pre-signal 3	acc. to Sec. 7.2.2
• Relay 4, 1 <sup>st</sup> RIM 36	Smoke sensor dirt	acc. to Sec. 7.2.2
• Relay 5, 1 <sup>st</sup> RIM 36	Sampling pipe blockage	acc. to Sec. 7.2.2
• Relay 1, 2 <sup>nd</sup> RIM 36	---	acc. to Sec. 7.2.2
• Relay 2, 2 <sup>nd</sup> RIM 36	---	acc. to Sec. 7.2.2
• Relay 3, 2 <sup>nd</sup> RIM 36	---	acc. to Sec. 7.2.2
• Relay 4, 2 <sup>nd</sup> RIM 36	---	acc. to Sec. 7.2.2
• Relay 5, 2 <sup>nd</sup> RIM 36	---	acc. to Sec. 7.2.2
• Reset key On / Off	On	On / Off
• Perform initial reset	---	On / Off
• OEM input signal	Off	Off / OEM input alarm / OEM input fault / Day/night switching
• Isolating the smoke sensor	normal operation	isolate / normal operation
• Filter monitoring (smoke sensor I)	Off	Off / On
• Filter service life	3 months	1 – 24 months
• Read out operation time	---	months / days
• Filter replacement	---	start / finish

# Commissioning

## 7.2.2 Relay allocation

The following criteria are freely programmable on max. 10 relays (5 units on 1<sup>st</sup> RIM 36, 5 units on 2<sup>nd</sup> RIM 36):

Smoke sensor / LS-Ü	General
Smoke sensor alarm	Fan fault
Pre-signal 1	Operating voltage fault
Pre-signal 2	Initial reset fault
Pre-signal 3	Lithium battery / clock fault
Smoke sensor dust	
Smoke sensor dirt	
Smoke sensor fault	
Sampling pipe blockage	
Pipe breakage sampling pipe	
Alarm 2	

The criteria can also be allocated using the OR function (e.g. smoke sensor dust or dirt together on one relay).

## 7.3 Starting up

The information on operation and display elements necessary for startup can be found in **Fig. 42**.



### Notice

Before the ASD 532 is switched on, all the precautions required for operation as described in Sec. 7.1 must be fulfilled.

### 7.3.1 Commissioning with EasyConfig

The workflow for commissioning with **EasyConfig** is shown below (planning without “ASD PipeFlow” calculation, without “ASD Config” configuration software). When RIM 36 additional modules are fitted, the RIM relays respond as described in Sec. 2.2.6 and 7.2.1, Table C. The default values as set out in Sec. 7.2.1 also apply to all other settings.

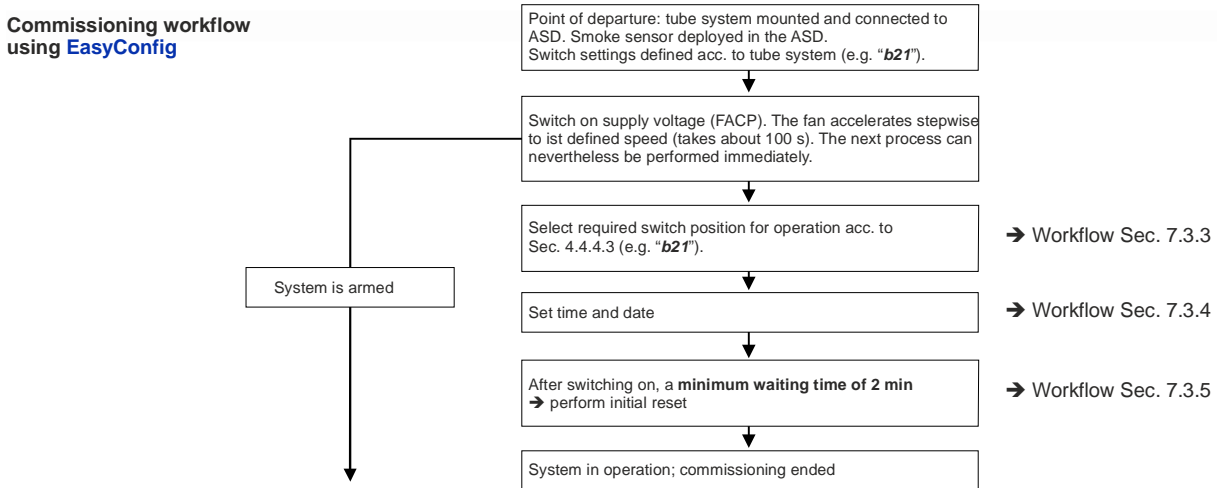

**Fig. 44 Workflow for commissioning using EasyConfig**

### 7.3.2 Commissioning with “ASD Config” configuration software

The workflow for commissioning when using the “ASD Config” configuration software is shown below. The “ASD Config” configuration software is required only if changes have to be made to the default configuration profile (Sec. 7.2.1) or if the “ASD PipeFlow” calculation software has been used.

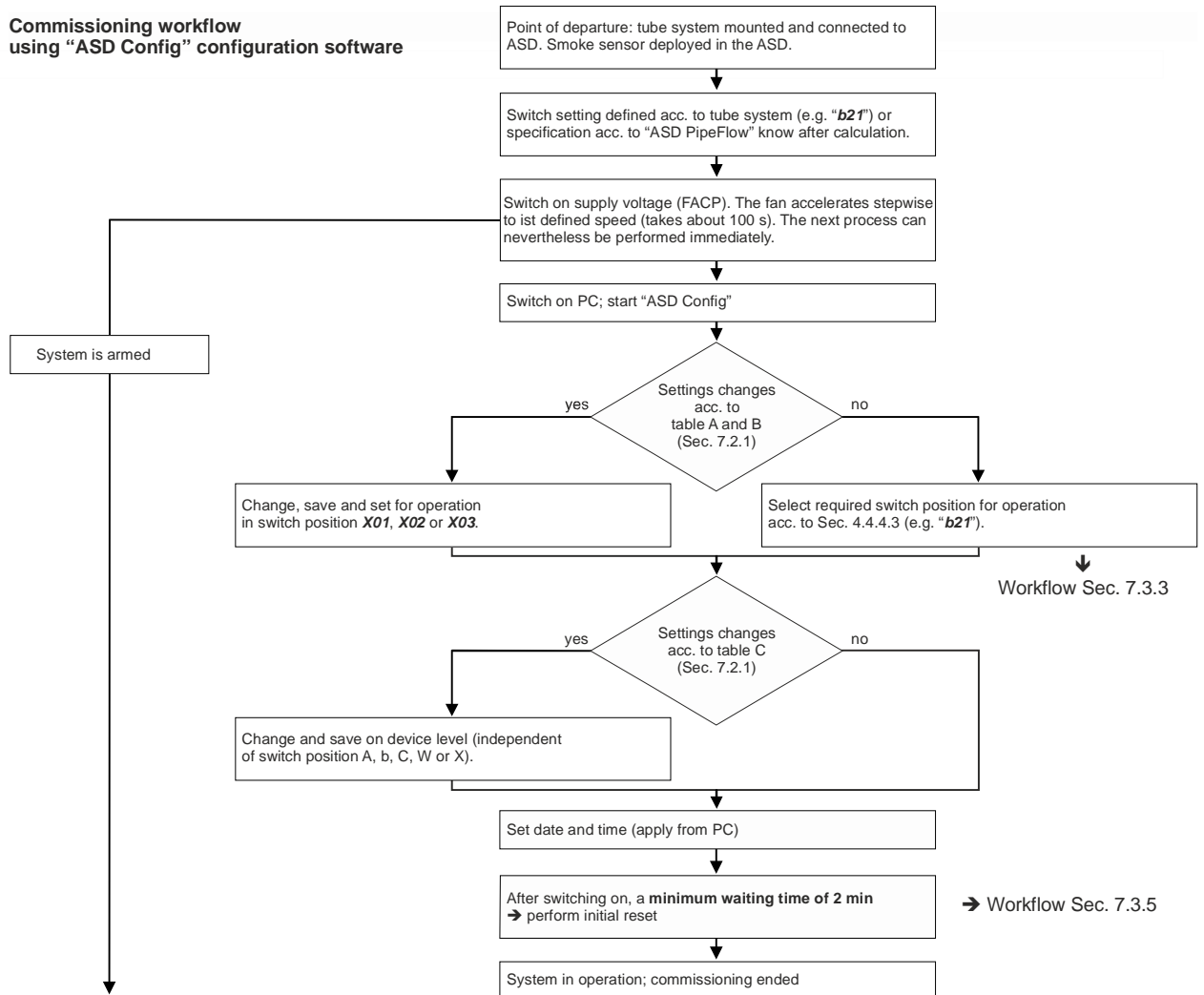

Fig. 45 Workflow for commissioning with “ASD Config” configuration software

### 7.3.3 Setting to pre-defined switch positions A11 to C31, W01 to W44







The following describes the procedure when the ASD 532 has to be set on one of the fixed parameterized switch settings **A11** to **C31** or **W01** to **W44**.

**Example:** The ASD 532 is to respond in compliance with EN 54-20, Class B. The sampling pipes are U-shaped, within system limit 2. As specified in Sec. 4.4.4.3, switch setting **b21** must be selected.



#### Notice

















Switch settings **W01** to **W44** may be used only after consulting with the manufacturer. The airflow monitoring values stored under those switch positions are **not** tested in accordance with EN.

Measure	Display	Procedure / remarks
(1)  Press key	flashing <b>C31</b>	<ul style="list-style-type: none"> <li>Displays the default setting</li> </ul>
(2)  Press key again until display on <b>b</b>	in succession <b>A / b</b>	<ul style="list-style-type: none"> <li>Displays the switch position group <b>b</b></li> </ul>
(3)  Press key	<b>b11</b>	<ul style="list-style-type: none"> <li>Displays the smallest possible switch position in group <b>b</b></li> </ul>
(4)  Press key until display on <b>b21</b>	in succession <b>b11 / b21</b>	<ul style="list-style-type: none"> <li>Displays the possible switch positions in group <b>b</b></li> </ul>
(5)  Press key	flashing <b>b - -</b> (approx. 4 x)	<ul style="list-style-type: none"> <li>New setting is programmed</li> </ul>
(6)  Press the key to check the change	flashing <b>b21</b>	<ul style="list-style-type: none"> <li>Displays the new setting</li> </ul>

### 7.3.4 Setting and polling the date and time

The following describes the procedure for setting the date and time with EasyConfig.

**Example:** Setting on 10 June 2016; 11:05:30

Measure	Display	Procedure / remarks
(1)  Press key	flashing <b>C31</b> or other	<ul style="list-style-type: none"> <li>Displays the default setting or the installation-specific switch position</li> </ul>
(2)  Press the key again until the display is on <b>T</b>	in succession <b>A / b / C / d / E / F / I / N / o / T</b>	<ul style="list-style-type: none"> <li>Displays the switch position group <b>T</b></li> </ul>
(3)  Press key	<b>RE</b> ①	<ul style="list-style-type: none"> <li>Date/time display, polling mode ①</li> </ul>
(4)  Press the key until the display is on <b>SE</b>	in succession <b>RE / SE</b>	<ul style="list-style-type: none"> <li>Date/time display, input mode</li> </ul>
(5)  Press key > Year	<b>Y13</b>	<ul style="list-style-type: none"> <li>Displays the year 2013 (example)</li> </ul>
(6)  Press the key until <b>Y16</b>	<b>Y16</b>	<ul style="list-style-type: none"> <li>Selected year 2016</li> </ul>
(7)  Press key > Month	<b>M01</b>	<ul style="list-style-type: none"> <li>Displays the month of January</li> </ul>
(8)  Press the key until <b>M06</b>	<b>M06</b>	<ul style="list-style-type: none"> <li>Selected month June</li> </ul>
(9)  Press key > Day	<b>d01</b>	<ul style="list-style-type: none"> <li>Displays the first day of the month</li> </ul>
(10)  Press the key until <b>d10</b>	<b>d10</b>	<ul style="list-style-type: none"> <li>Selected day is 10</li> </ul>
(11)  Press key > Hour	<b>H01</b>	<ul style="list-style-type: none"> <li>Displays the first hour in the day</li> </ul>
(12)  Press the key until <b>H11</b>	<b>H11</b>	<ul style="list-style-type: none"> <li>Selected hour is 11</li> </ul>
(13)  Press key > Minute	<b>M01</b>	<ul style="list-style-type: none"> <li>Displays the first minute of the hour</li> </ul>
(14)  Press the key until <b>M05</b>	<b>M05</b>	<ul style="list-style-type: none"> <li>Selected minute is 05</li> </ul>
(15)  Press key > Second	<b>S00</b>	<ul style="list-style-type: none"> <li>Displays second 00</li> </ul>
(16)  Press the key until <b>S30</b>	<b>S30</b>	<ul style="list-style-type: none"> <li>Selected second 30</li> </ul>
(17)  Press the key, date and time are programmed	flashing <b>T - -</b> (approx. 2 x)	<ul style="list-style-type: none"> <li>The date is set to 10.06.2016, and the clock starts to run from the time 11:05:30</li> </ul>



#### Notice

##### ① Poll date and time:

In the **T > RE** switch position, pressing "OK" outputs the currently set date and the current time on the ASD 532.

**Example:** In sequence **Y16 > M06 > d10 > H11 > M05 > S58**.

## 7.3.5 Initial reset

When commissioning the ASD 532, an initial reset is required. When this happens, the airflow monitoring is automatically aligned to the connected sampling pipe.



### Notices

- In principle the initial reset should be carried out under “normal system conditions”, i.e. with any ventilation systems, air conditioning systems, etc., running in “normal operation”.
- If a maintenance sampling hole is provided, it must be closed with adhesive tape or the maintenance clip.
- The initial reset must be performed with normal ventilation for equipment monitoring of ventilated objects.
- The housing cover must be closed for the initial reset when monitoring closed air-conditioning and ventilation ducts. By means of Config over Line, “ASD Config” via networking, or via external Ethernet cable (airtight compliant with the manufacturer’s specifications).
- If there is an expansion, conversion, retrofitting or repair on the sampling pipe, an initial reset is imperative.
- An initial reset must be performed after the fan speed has been changed.
- After an FW upgrade, an initial reset is required only if expressly mentioned in the relevant firmware description.
- Before performing an initial reset after switching on the ASD 532, a **waiting time of at least 2 min** must be observed.

Measure	Display	Procedure / remarks
(1)  Press key	flashing <b>C31</b> or other	• Displays the default setting or the installation-specific switch position
(2)  Press the key again until the display is on <b>U</b>	in succession <b>A / b / C / d / E / F / I / N / o / T / U</b>	• Displays the switch position group <b>U</b>
(3)  Press key > <b>U01</b>	<b>U01</b>	• Displays initial reset on
(4)  Press the key again	flashing <b>U - -</b> (5 to max. 120 s)	• Initial reset in progress
(5) Wait	flashing point (watchdog indicator)	• Initial reset completed







## 7.3.6 Displaying the firmware version

On the ASD 532 the switch position **F** can be used to display the version of the firmware currently loaded.

Measure	Display	Procedure / remarks
(1)  Press key	flashing <b>C31</b> or other	• Displays the default setting or the installation-specific switch position
(2)  Press the key again until the display is on <b>F</b>	in succession <b>A / b / C / d / E / F</b>	• Displays the switch position group <b>F</b>
(3)  Press key	flashing after approx. 2 s, e.g. <b>V01</b> . Pause <b>01</b> . Pause <b>00</b>	• Displays the firmware version, in this case 01.01.00

### 7.3.7 Logging off additional modules and the SD memory card

The additional modules (XLM 35, ML-SFD, RIM 36, SIM 35, UIM 35) or the SD memory card are automatically detected when the device is switched on; from that point onwards, they are monitored and fully functional. The SD memory card begins with data logging, recognisable on the flashing Com LED on the AMB. To eject the SD memory card or remove a subsequently fitted additional module (e.g. because it is not being used), the additional modules and SD memory card must first be logged off via the AMB 32 main board.

<b>Notice</b>		
 <p>A time-out (approx. 15 s) is configured for the logoff procedure. During this time the additional modules can be electrically disconnected from the AMB 32 trouble-free or the SD memory card can be removed from the ASD. If no component is removed during that time (including removing the SD memory card), the additional modules are re-activated and data logging continues.</p>		
Measure	Display	Procedure / remarks
(1)  Press key	flashing <b>C31</b> or other	<ul style="list-style-type: none"> <li>Displays the default setting or the installation-specific switch position</li> </ul>
(2)  Press the key again until the display is on 	in succession <b>A / b / C / d / E / F / I / N / o</b>	<ul style="list-style-type: none"> <li>Displays the switch position group <b>o</b></li> </ul>
(3)  Press key	<b>o00</b>	<ul style="list-style-type: none"> <li>Displays logoff additional module</li> </ul>
(4)  Press the key again	flashing <b>o - -</b> (timeout approx. 15 s)	<ul style="list-style-type: none"> <li>Start logoff procedure, duration approx. 15 s</li> </ul>
(5) Electrically disconnect (flat cable) the relevant additional module from the AMB 32 within the logoff time (15 s) or remove the SD memory card.		<ul style="list-style-type: none"> <li>If the module is not electrically disconnected from the AMB 32 within 15 s (including removal of the SD memory card), it is re-activated and data logging continues.</li> </ul>

### 7.4 Re-programming

<b>Notice</b>	
 <p>The parameters are configured ex factory with default states and values so that the triggering properties comply with EN 54-20. Changing the parameters may result in non-compliance with EN 54-20. Any adjustments or modifications to the ASD 532 using the “ASD Config” configuration software or the user interface on the FACP may only be carried out by the manufacturer or by qualified personnel trained by the manufacturer.</p>	

#### 7.4.1 Re-programming on the ASD 532

If a different switch setting has to be selected within the present system limits (**A11** to **C31** or **W01** to **W44**), re-programming is performed as described in Sec. 7.3.3.

#### 7.4.2 Re-programming with “ASD Config” configuration software

When changing parameters as described in Sec. 7.2.1 and 7.2.2, use the “ASD Config” configuration software.

#### 7.4.3 Re-programming from SecuriFire / Integral with XLM 35 / ML-SFD

When connecting to the SecuriFire or Integral FACP via an XLM 35 or ML-SFD, control operations and changes can be made to the ASD device configuration directly from the FACP. For this purpose the FACP user software “SecuriFire Studio” and “[Integral Application Center](#)” are used to start the “ASD Config” configuration software for access to the ASDs; the configuration software is then used to make changes to the ASD 532.

## 7.5 Download new firmware to the ASD 532



An FW upgrade can be performed in two ways:

- From SD memory card
- Via Ethernet port from the “ASD Config” configuration software.

### 7.5.1 FW upgrade from SD memory card

When upgrading the FW from the SD memory card, first the new FW must be saved to the SD memory card in the topmost directory (not in a sub-directory).

The workflow for upgrading the FW from the SD memory card is described below:

 <b>Notice</b> The firmware download triggers a fault relay. When upgrading the FW on the ASD 532, it is therefore absolutely essential that <b>fire incident controls and remote alerting</b> on superordinate systems (FACP) are switched off beforehand.		
Measure	Display	Procedure / remarks
(1) If present, log off the SD memory card via switch position <b>o</b> and remove.		<ul style="list-style-type: none"> <li>• See Sec. 7.3.7</li> </ul>
(2) Copy the FW file to be transferred to the SD memory card and then re-insert the SD memory card in the ASD.		<ul style="list-style-type: none"> <li>• On the SD memory card to the <b>topmost</b> level (no sub-directory). <b>Important: only one</b> FW file may be saved.</li> </ul>
(3) On the AMB 32, press and hold the “OK” key and afterwards <b>briefly press</b> the “HW reset” button. Release the “OK” key.	<b>bL</b> - (“Bootloader” display)	<ul style="list-style-type: none"> <li>• Continuously lit “Wdog” indicator</li> <li>• “Al” &amp; “Fl” LEDs continuously lit</li> <li>• ASD triggers fault</li> </ul>
(4) Transmission to the ASD 532 begins (takes approx. 10 s) → see also ①	<b>Sd</b> - (displays “from SD memory card”)	<ul style="list-style-type: none"> <li>• Transmission running</li> </ul>
(5) FW upgrade is completed	flashing - - - (approx. 4 x)	<ul style="list-style-type: none"> <li>• Fault is reset</li> <li>• ASD start phase running (LED “Fault” flashes about 60 s)</li> <li>• ASD continues running with the previous installation-specific settings</li> <li>• <b>FW upgrade is completed</b></li> </ul>
 <b>Notice</b> Afterwards, normal data logging begins automatically on the still inserted SD memory card. If this is not wanted, the SD memory card must be logged off and removed after the FW upgrade (via switch position <b>o</b> ).		
(6) After a waiting time of at least 2 min. from point (5) an initial reset must be performed. <b>Attention:</b> only necessary if expressly mentioned in the relevant firmware description.	according to Sec. 7.3.5	<ul style="list-style-type: none"> <li>• Observe the firmware description for the loaded FW</li> <li>• According to Sec. 7.3.5</li> </ul>

- ① If at step (4) an immediate cancellation of the **Sd** - display occurs (reason: incompatible, third-party or no FW on the SD memory card), refer to the instructions of the concerned firmware description (**changes:** file designation of the FW; **compatibility:** required HW for this FW).

### 7.5.2 FW upgrade from PC via “ASD Config” configuration software

Here the FW upgrade is via the Ethernet interface of the LMB 35 using the “ASD Config” configuration software.



#### Notice

The firmware download triggers a fault relay. When upgrading the FW on the ASD 532, it is therefore absolutely essential that **fire incident controls and remote alerting** on superordinate systems (FACP) are switched off beforehand.

Measure	Display	Procedure / remarks
(1) In “ASD Config” select “ <b>Tools</b> ” > “ <b>Download firmware</b> ”		<ul style="list-style-type: none"> <li>The “<b>Download firmware</b>” window opens</li> </ul>
(2) Under “ <b>Firmware image</b> ” > “ <b>Select</b> ” find the directory containing the new FW. Select the file with the new firmware and click “ <b>Open</b> ”		<ul style="list-style-type: none"> <li>Selection of the new firmware</li> </ul>
(3) Under “ <b>Control</b> ” > press “ <b>Download</b> ” → the steps (4) to (5) proceed automatically	<b>bL</b> - (“ <b>Bootloader</b> ” display)	<ul style="list-style-type: none"> <li>Continuously lit “<b>Wdog</b>” indicator</li> <li>LED „<b>Al1</b>” and „<b>Flt1</b>” (and „<b>Al2</b>” and „<b>Flt2</b>”) continuously lit</li> <li>ASD triggers fault</li> </ul>
(4) Transmission to the ASD begins (takes approx. 10 s)	<b>PC</b> - (displays “from PC”)	<ul style="list-style-type: none"> <li>Transmission running → “<b>Download firmware</b>” window under “<b>Status</b>” shows the progress of the upgrade procedure</li> </ul>
(5) FW upgrade is completed	flashing - - - (approx. 4 x)	<ul style="list-style-type: none"> <li>Fault is reset</li> <li>ASD continues running with the previous system-specific settings</li> <li><b>Firmware upgrade is completed</b></li> </ul>
(6) Carry out a new initial reset after waiting a minimum of 2 min from Point (5). <b>Attention:</b> only necessary if expressly mentioned in the relevant firmware description.	according to Sec. 7.3.5	<ul style="list-style-type: none"> <li>Observe the firmware description for the loaded FW</li> <li>According to Sec. 7.3.5</li> </ul>

### 7.6 Measurements

The ASD supply voltage on terminals 1 and 2 must be checked (check also terminals 3 and 4 in the case of a redundant supply). The voltage must be between 17.6 and 27.6 V for a correctly set FACP voltage supply (not emergency current operation). The value depends on the line length. Once commissioning is completed, the measured voltage value is to be entered in the commissioning protocol (see Sec. 7.9).

With the conductor cross-section determined and installed as described in Sec. 4.9.2, this voltage range must always be available at the end of the electrical installation – i.e. at the ASD 532 – to ensure that the ASD 532 is able to operate fault-free (see also Sec. 4.9.2).







#### Notices

- If the measured value is outside the specified range, the ASD 532 may malfunction or even become damaged (over 30 VDC).
- Voltage values that are too low can be caused by insufficiently dimensioned conductor cross-sections or an incorrectly set FACP voltage.

### 7.6.1 Reading out the set configuration and airflow

Besides measuring the supply voltage on the ASD 532, the set configuration (selected switch settings **A11** to **C31** and **W01** to **W44** when commissioning according to Sec. 4.4.4.3 or parameterized switch settings **X01** to **X03**) as well as the airflow values (rate of airflow change from the time of the initial reset) must be recorded and entered in the commissioning protocol (see Sec. 7.9).

Measure	Display	Procedure / remarks
(1)  <b>Poll response grade</b> Briefly press key	flashing, e.g. <b>C31</b> or other	<ul style="list-style-type: none"> <li>When commissioning, display of the switch settings <b>A11</b> to <b>C31</b>, <b>W01</b> to <b>W44</b>, <b>X01</b> to <b>X03</b></li> </ul>
(2)  Press the key again until display on <b>N</b>	in succession <b>A / b / C / d / E / F / I / N / o / T / U / V</b>	<ul style="list-style-type: none"> <li>Displays the switch position group <b>V</b></li> </ul>
(3)  Press key > <b>V01</b>	<b>V01</b>	<ul style="list-style-type: none"> <li>Selects the volume rate of flow measurement for sampling pipe</li> </ul>
(4)  Press the key again	flashing after approx. 2 s, e.g. <b>099</b>	<ul style="list-style-type: none"> <li>Display airflow for sampling pipe = 99% of initial reset (initial reset = 100%)</li> </ul>

**Meaning:** Value < 100% = direction pipe blockage / > 100% = direction pipe breakage











#### Notice

According to EN 54-20 a change in the airflow that is greater than  $\pm 20\%$  must be reported as a fault. After an initial reset, the airflow shows 100% in the ASD 532 aspirating smoke detector when the sampling pipe is correct and clean. In switch positions **A11** to **C31** a fault is triggered if the change in value is greater than  $\pm 20\%$  – i.e. below 80% or above 120% – and the **LS-Ü** delay time of 300 s has expired.

### 7.6.2 Read out of the set IP configuration

The currently set IP configuration can be read out via the **N** switch position. Further, a factory setting of the IP configuration can be performed.

Measure	Display	Procedure / remarks
(1)  <b>Polling IP configuration</b> Press the key until display on <b>N</b>	in succession <b>A / b / C / d / E / F / I / N</b>	<ul style="list-style-type: none"> <li>Displays switch position group <b>N</b></li> </ul>
(2)  Press key > <b>RE</b>	<b>RE</b>	<ul style="list-style-type: none"> <li>Displays <b>RE</b> polling mode</li> </ul>
(3)  Press key	flashing after approx. 2 s: <b>IP / 169. / 254. / 001. / 001</b> <b>Sub / 255. / 255. / 000. / 000</b> <b>GA / 169. / 254. / 000. / 254</b>	Display of the factory setting: <ul style="list-style-type: none"> <li>Displays the IP address</li> <li>Displays the IP subnet mask</li> <li>Displays the default gateway</li> </ul>
(4)  <b>Factory setting</b> Press the key until display on <b>N</b>	in succession <b>A / b / C / d / E / F / I / N</b>	<ul style="list-style-type: none"> <li>Displays switch position group <b>N</b></li> </ul>
(5)  Press key > <b>RE</b>	<b>RE</b>	<ul style="list-style-type: none"> <li>Displays <b>RE</b> polling mode</li> </ul>
(6)  Press key > <b>SE</b>	<b>SE</b>	<ul style="list-style-type: none"> <li>Displays <b>SE</b> input mode</li> </ul>
(7)  Press key > <b>FSE</b>	<b>FSE</b>	<ul style="list-style-type: none"> <li>Displays <b>FSE (FactorySEttings)</b></li> </ul>
(8)  Press key 3 x	flashing - - - (approx. 4 x)	<ul style="list-style-type: none"> <li>The IP configuration was reset to the factory setting (see (3))</li> </ul>

## 7.7 Testing and checking

In addition to the sampling pipe checks set out in Sec. 7.1, the correct transmission of alarms (zone and line) on the FACP is to be checked by triggering faults or alarms on the ASD 532. These tests are to be entered in the commissioning protocol (see also Sec. 7.9).



### Notice

Block or deactivate fire incident control and remote alerting on the superordinate FACP.

- ① Reset the ASD 532 between each check (preferably on the FACP, as a reset on the ASD does not reset the FACP). Likewise, after the tests, restore the original state of the sampling pipe (re-open taped-up sampling holes, seal maintenance sampling holes).

Test event	Procedure	Action
Checking the airflow monitoring ①	Tape up the sampling holes (adhesive tape); number depends on the pipe configuration	<ul style="list-style-type: none"> <li>• As soon as the resulting change in the volume rate of flow exceeds <math>\pm 20\%</math> (which can also be checked using switch position <b>V</b> according to Sec. 7.6.1), the "Fault" LED begins to flash.</li> <li>• When the <b>LS-Ü</b> delay expires (300 s), the ASD triggers a fault → fault on FACP.</li> </ul>
Check alarm release ①	Apply smoke to maintenance sampling hole or sampling hole, see Sec. 7.7.1.	<ul style="list-style-type: none"> <li>• ASD triggers an alarm → alarm on FACP; check correct alarm transmission (zone/area triggering) on the FACP.</li> <li>• If there are pre-signals they are also actuated</li> </ul>

### 7.7.1 Checking the alarm release

When **commissioning** and after any changes (repairs) to the sampling pipe the alarm release **must** take place from the **last sampling hole** on the pipe branch. This tests the uniformity throughout the entire sampling pipe.

To test alarm actuation during regular **maintenance and service work**, the ASD 532 can be made to actuate on the **maintenance sampling hole**. Because the sampling pipes are continuously monitored for proper functioning, testing via the sampling pipe is normally not necessary. Once the test is completed, re-seal the maintenance sampling hole (using adhesive tape or maintenance clip).

If testing via the maintenance sampling hole is inadequate, testing can be carried out via the sampling pipe as follows:

- **Point-by-point testing of the sampling holes**; apply smoke directly to individual or several sampling holes. Apiarist smoke or wax/joss sticks are suitable for this purpose.
- **Area-wide testing of the sampling pipe**; area-wide testing of the sampling pipe using fire tests is reasonable and practicable only following EN 54-20.



### Notice

If genuine fire tests are to be carried out, the relevant local authorities (fire service) are to be consulted beforehand; the tests themselves are to be carried out by trained specialists (manufacturer) only.

## 7.7.2 Test triggerings



## Notice about test triggerings

Fire incident control and remote alerting must be blocked or deactivated on the superordinate FACP.



















- ① Reset the ASD 532 between each check (preferably on the FACP, as a reset on the ASD does not reset the FACP).

Measure	Display	Procedure / remarks
(1)  Press key	flashing <b>C31</b> or other	<ul style="list-style-type: none"> <li>Displays the default setting or the installation-specific switch position</li> </ul>
(2) <b>Test alarm</b> Press the key again until the display is on <b>I</b>	in succession <b>A / b / C / d / E / F / I</b>	<ul style="list-style-type: none"> <li>Displays switch position group <b>I</b></li> </ul>
(3)  Press key > <b>IA1</b>	<b>IA1</b> (possible selection here: <b>IA1 / IF1 / IP1 / IE1</b> )	<ul style="list-style-type: none"> <li>Displays test mode "Test alarm from <i>EasyConfig</i>"</li> </ul>
(4)  Press key <b>3 x</b>	flashing <b>IA1</b> (until reset)	<ul style="list-style-type: none"> <li>ASD 532 triggers Alarm → via relay or XLM / ML-SFD to FACP → reset from FACP ①</li> </ul>
(5) <b>Test fault</b> Press key again until display on <b>I</b>	in succession <b>A / b / C / d / E / F / I</b>	<ul style="list-style-type: none"> <li>Displays switch position group <b>I</b></li> </ul>
(6)  Press key	<b>IA1</b>	<ul style="list-style-type: none"> <li>Displays test mode "Test alarm from <i>EasyConfig</i>"</li> </ul>
(7)  Press the key several times until display on <b>IF1</b>	in succession <b>IA1 / IF1</b>	<ul style="list-style-type: none"> <li>Displays test mode "Test alarm from <i>EasyConfig</i>"</li> </ul>
(8)  Press key <b>3 x</b>	flashing <b>IF1</b> (until reset)	<ul style="list-style-type: none"> <li>ASD 532 triggers fault → via relay or XLM / ML-SFD to FACP → reset from FACP ①</li> </ul>
(9) <b>Test pre-signal</b> Press key again until display on <b>I</b>	in succession <b>A / b / C / d / E / F / I</b>	<ul style="list-style-type: none"> <li>Displays switch position group <b>I</b></li> </ul>
(10)  Press key	<b>IA1</b>	<ul style="list-style-type: none"> <li>Displays test mode "Test alarm from <i>EasyConfig</i>"</li> </ul>
(11)  Press the key several times until display on <b>IP1</b>	in succession <b>IA1 / IF1 / IP1</b>	<ul style="list-style-type: none"> <li>Displays test mode "Test pre-signal from <i>EasyConfig</i>"</li> </ul>
(12)  Press key <b>3 x</b>	flashing <b>IP1</b> (until reset)	<ul style="list-style-type: none"> <li>ASD 532 triggers pre-signal → via relay or XLM / ML-SFD to FACP → reset from FACP ①</li> </ul>
(13) <b>Test alarm 2</b> Press key again until display on <b>I</b>	in succession <b>A / b / C / d / E / F / I</b>	<ul style="list-style-type: none"> <li>Displays switch position group <b>I</b></li> </ul>
(14)  Press key	<b>IA1</b>	<ul style="list-style-type: none"> <li>Displays test mode "Test alarm from <i>EasyConfig</i>"</li> </ul>
(15)  Press the key several times until display on <b>IE1</b>	in succession <b>IA1 / IF1 / IP1 / IE1</b>	<ul style="list-style-type: none"> <li>Displays test mode "Test alarm 2 from <i>EasyConfig</i>"</li> </ul>
(16)  Press key <b>3 x</b>	flashing <b>IE1</b> (until reset)	<ul style="list-style-type: none"> <li>ASD 532 triggers Alarm 2 → via relay or XLM / ML-SFD to FACP → reset from FACP ①</li> </ul>

## 7.8 Filter monitoring operation









The following filter monitoring operations are available on the ASD 532 (see also Sec. 2.2.20):

- Filter monitoring On/Off;
- Change filter service life (in months, 1 – 24) / read out filter service life (configured and expired);
- Start filter replacement (also possible via the “Reset” key) / finish filter replacement (“Reset”).

<b>Notice</b>		
 To prevent false alarms, the aspirating smoke detector is set to “Isolate” when filter replacement is active.		
Measure	Display	Procedure / remarks
(1)  <b>Filter monitoring On/Off</b> Press key until display on <b>d</b>	in succession <b>A / b / C / d</b>	• Displays switch position group <b>d</b>
(2)  Press key > <b>RE</b>	<b>RE</b>	• Displays <b>RE</b> polling mode
(3)  Press key until display on <b>SE</b>	in succession <b>RE / SE</b>	• Displays <b>SE</b> input mode
(4)  Press key > <b>on</b>	<b>on</b> (possible selection here: <b>on / T / R / oFF</b> )	• Display <b>on</b> filter monitoring “On”
(5)  Press key > <b>ch1</b>	<b>ch1</b>	• Displays <b>ch1</b> for <b>channel I</b>
(6)  Press key	flashing - - - (ca. 3 x)	• Filter monitoring is switched on
(1)  <b>Read out filter service life</b> Press key until display on <b>d</b>	in succession <b>A / b / C / d</b>	• Displays switch position group <b>d</b>
(2)  Press key > <b>RE</b>	<b>RE</b>	• Displays <b>RE</b> polling mode
(3)  Press key again <i>Output for channel I</i>	In sequence: <b>ch1</b> output for channel I <b>on</b> filter monitoring is “On” <b>T03</b> Filter service life = 3 months <b>R</b> last filter replacement <b>Y16</b> year 2016 <b>M10</b> month October <b>d31.</b> day 31 <b>o10</b> operating time in month	• 3 months = default, range = 1 – 24 months  • 0 – 24, less than 10 = rounded off to 0.5 months
(1)  <b>Change filter service life</b> <u>Example 12 months</u> Press key until display on <b>d</b>	in succession <b>A / b / C / d</b>	• Displays switch position group <b>d</b>
(2)  Press key > <b>RE</b>	<b>RE</b>	• Displays <b>RE</b> polling mode
(3)  Press key until display on <b>SE</b>	in succession <b>RE / SE</b>	• Displays <b>SE</b> input mode
(4)  Press key > <b>SE</b>	<b>on</b> (possible selection here: <b>on / T / R / oFF</b> )	• Displays <b>on</b> filter monitoring “On”
(5)  Press key until display on <b>T</b>	in succession <b>on / T</b>	• Displays <b>T</b> filter service life
(6)  Press key > <b>ch1</b>	<b>ch1</b>	• Displays <b>ch1</b> for <b>channel I</b>
(7)  Press key > <b>T06</b>	<b>T06</b>	• Displays 6 months (default)
(8)  Press key until display on <b>T12</b>	in succession <b>T01 to T24</b>	• Displays filter service life in months
(9)  Press key, program new filter service life	flashing - - - (ca. 3 x)	• The filter service life for <b>channel I</b> is programmed for 12 months

→→

Continuation:

Measure	Display	Procedure / remarks
(1)  <b>Start filter replacement</b>  Press key until display on <b>d</b>	in succession <b>A / b / C / d</b>	<ul style="list-style-type: none"> <li>Displays switch position group <b>d</b></li> </ul>
(2)  Press key > <b>RE</b>	<b>RE</b>	<ul style="list-style-type: none"> <li>Displays <b>RE</b> polling mode</li> </ul>
(3)  Press key until display on <b>SE</b>	in succession <b>RE / SE</b>	<ul style="list-style-type: none"> <li>Displays <b>SE</b> output mode</li> </ul>
(4)  Press key > <b>SE</b>	<b>on</b> (possible selection here: <b>on / T / R / off</b> )	<ul style="list-style-type: none"> <li>Displays <b>on</b> filter monitoring "On"</li> </ul>
(5)  Press key until display on <b>R</b>	in succession <b>on / T / R</b>	<ul style="list-style-type: none"> <li>Displays <b>R</b> filter replacement</li> </ul>
(6)  Press key > <b>ch1</b>	<b>ch1</b>	<ul style="list-style-type: none"> <li>Displays <b>ch1</b> for <b>channel I</b></li> </ul>
(7)  Press key > <b>.Fr</b>	flashing <b>.Fr</b>	<ul style="list-style-type: none"> <li>Displays <b>.Fr</b> "Filter replacement started"</li> <li>ASD smoke sensor I is "isolated"</li> <li>ASD triggers fault</li> <li>"Fault" LED is lit</li> <li>Filter service life is set to "0"</li> </ul>
(8) Open dust filter unit and replace dirty filter element with clean replacement filter element. Afterwards, close the dust filter unit.	flashing <b>.Fr</b>	<ul style="list-style-type: none"> <li>The date of the replacement must be entered on the new replacement filter element or in the commissioning log.</li> </ul>
(9) Press "Reset" on the ASD.	Displays <b>.Fr</b> no lit	<ul style="list-style-type: none"> <li>Filter replacement is completed</li> <li>Fault is reset</li> <li>Isolation is removed</li> </ul>

① Also, when the ASD 532 housing is closed, the "Start filter replacement" function can be activated by means of the "**Reset**" key (provided the filter monitoring is activated). To do so, press the key **longer than 15 s** (attention: lamp test after 10 s). After 15 s the filter replacement is started and indicated by switching to the "Isolate" state (LED "Fault"). The filter replacement is completed by pressing the "Reset" key again. When the "Reset" key is deactivated (via "ASD Config"), the "Start filter replacement" function is not accessible.

## 7.9 Commissioning protocol

The ASD 532 ships with a commissioning protocol (fold-out) included in the scope of delivery. All of the measurements and tests carried out during commissioning and maintenance are to be entered on the protocol, which is then signed.

Notices



- When performing maintenance work or after certain other events, conclusions can be drawn concerning the commissioning state of the ASD 532 based on the commissioning protocol. The protocol also serves as a kind of life history of the ASD 532.
- The commissioning protocol is to be filled out conscientiously and fully and stored in the ASD 532. If required, a copy can be made and stored in the system dossier.

## 8 Operation



### Notice

The following points must be observed when operating the ASD 532 aspirating smoke detector:

- System performance depends on the sampling pipe. Any extensions or modifications to the installation may cause functional faults. The effects of such changes must be checked. It is very important to adhere to the specifications in Sec. 4 (Planning). The “ASD PipeFlow” calculation software is available from the manufacturer.

### 8.1 Operation and display elements

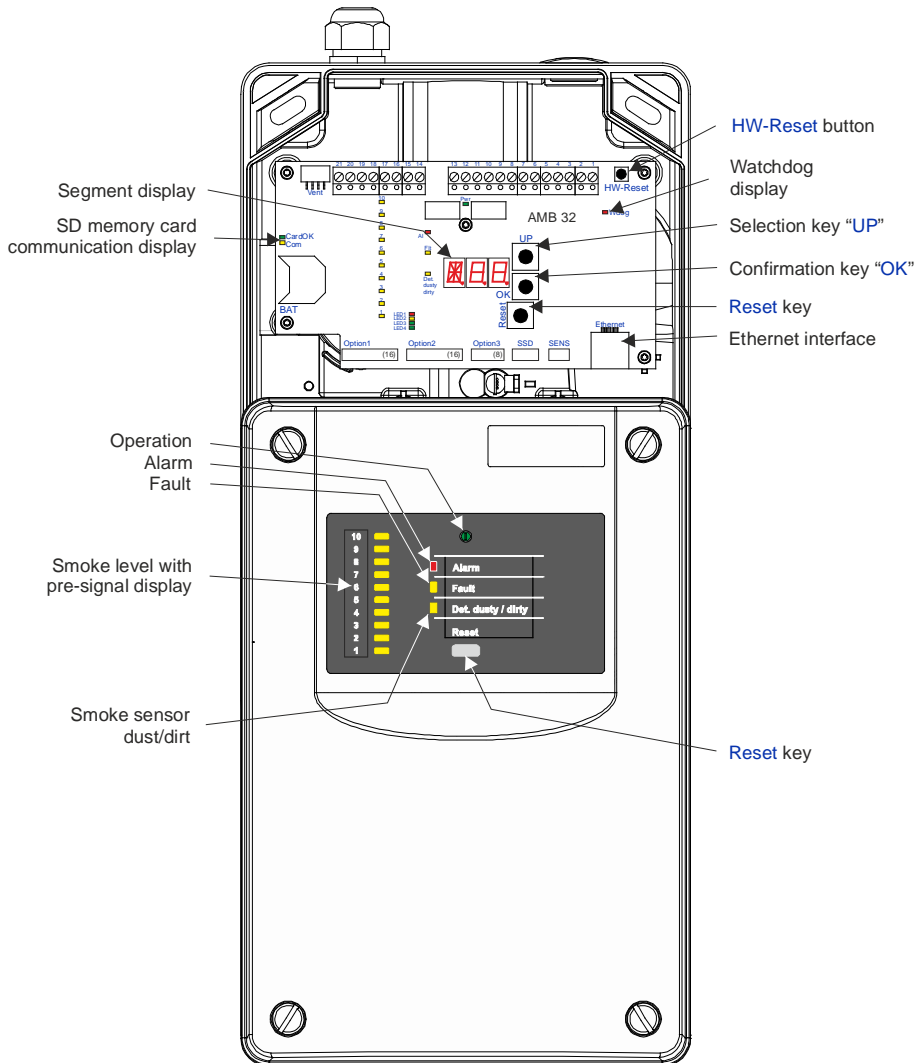

**Fig. 46 View of the operation and display elements**

The control unit has a “Reset” key for resetting triggered events (alarms/faults) directly on the ASD 532. If the “Reset” key is pressed longer than 10 s, all indicators flash together on the control unit as “lamp test”.

Two 7-segment displays, an alphanumeric display, and two keys (“UP” / “OK”) are fitted to the AMB 32 main board inside the device.

## 8.2 Functional sequence of operation

The operation of the ASD 532 aspirating smoke detector in normal mode (after commissioning) is limited to switching on/off or to resetting a triggered event (alarm/fault). Operation is generally via the FACP, with input of the “Zone On/Off” and “Reset” functions (on “Reset external” input of the ASD 532).

Events triggered on the ASD 532 can be reset locally using the “Reset” key on the control unit or by briefly actuating the “Reset External” input. The reset is possible only if the triggering event is no longer pending (e.g. smoke sensor no longer has smoke). The application of a continuous signal at the “Reset external” input also deactivates (switches off) the ASD 532 (see also Sec. 2.2.8 and 6.6.2).



### Notice

A local reset does not reset a higher-order FACP. It may also happen that the reset in the ASD 532 triggers a fault in the superordinate line of the FACP.

To aid commissioning the ASD 532, there are two 7-segment displays, an alphanumeric display, and two keys (“UP” and “OK”) inside the device on the AMB 32 Main Board. These elements provide a type of rotary switch function, i.e. displays and positions in the range **A00** to **Z99** may appear.

These elements are used when commissioning the ASD 532. Device settings for predefined system limits can also be called up – **EasyConfig**. These pre-defined positions are stored with normative values for response sensitivity, airflow monitoring (LS-Ü) and pipe configuration. They also contain positions which allow deviations from the normative limits with regard to airflow monitoring. The **EasyConfig** process allows the device to be commissioned without the “ASD Config” software. If system-specific programming has to be carried out (e.g. after a calculation with “ASD PipeFlow” or when programming RIM 36), the “ASD Config” configuration software must be used.

## 8.3 Switch positions

Listed below are the switch positions that can be called up via the segment display and the “UP” / “OK” keys on the AMB 32. The switch positions can be used for inputs (**A / b / C / d / I / o / T / U / W / X**) or for polling purposes (**E / F / N / T / V**).

Stored under the rotary switch procedure is a **time-out** (approx. 5 s). If within this time period a process is not continued or completed, it is interrupted and the segment display automatically returns to the normal state (flashing point).

Pos.	Area / Display	Purpose	Meaning / Procedure ①
<b>A</b>	<b>A11</b>	Normative system limits compliant with EN 54-20, class A	see Sec. 4.4.4.3 and 7.3.3
<b>b</b>	<b>b11 / b21</b>	Normative system limits compliant with EN 54-20, class B	see Sec. 4.4.4.3 and 7.3.3
<b>C</b>	<b>C11 / C21 / C31</b>	Normative system limits compliant with EN 54-20, class C	see Sec. 4.4.4.3 and 7.3.3
<b>d</b>	Polling ( <b>Read = RE</b> ) Setting ( <b>Set = SE</b> ) ↳ <b>on / T / R / oFF</b>	<b>on</b> = On / <b>oFF</b> = Off <b>T</b> = <b>Time</b> , filter service life <b>R</b> = <b>Filter Replacement</b> <b>ch1</b> = channel I	see Sec. 7.8
<b>E</b>	<b>E01 to E99</b> ↳ <b>G00 to G99</b>	Event memory, 99 events ( <b>E01</b> = last event) ↳ Event group <b>G00 to G99</b>	see Sec. 8.5.3
<b>F</b>	<b>F00 to F99</b> (3 x)	Displays the firmware version	see Sec. 7.3.6
<b>I</b>	<b>IA1</b> <b>IF1</b> <b>IP1</b> <b>IE1</b>	Trigger ( <b>Initiate</b> ); Test alarm ( <b>IA1</b> ), up to the FACP Test fault ( <b>IF1</b> ), up to the FACP Test pre-signal ( <b>IP1</b> ), up to the FACP Test Alarm 2 ( <b>IE1</b> ), up to the FACP	see Sec. 7.7.2
<b>N</b>	Polling ( <b>Read = RE</b> ) <b>IP / Sub / GA</b> ↳ <b>169. / 254. / 001. / 001</b> (default) Setting ( <b>Set = SE</b> ) ↳ <b>FSE</b>	<b>Polling IP configuration (Network)</b> ; IP address ( <b>IP</b> ), <b>Subnet (Sub)</b> , <b>Gateway (GA)</b>  <b>IP configuration factory setting</b> ; <b>FSE = FactorySEttings</b>	see Sec. 7.6.1
<b>o</b>	<b>o00</b>	<b>Log off additional modules</b> ; (optional modules, all at same time)	see Sec. 7.3.7
<b>T</b>	<b>Y10 to Y99 / M01 to M12</b> <b>d01 to d31 / H00 to H23</b> <b>M00 to M59 / S00 to S59</b>	Polling ( <b>RE</b> ) and setting ( <b>SE</b> ) the date and time	see Sec. 7.3.4
<b>U</b>	<b>U01</b>	Executes initial reset	see Sec. 7.3.5
<b>V</b>	<b>V01, 000 to 255</b>	Volume rate of flow output in %	see Sec. 7.6.1
<b>W</b>	<b>W01 to W44</b>	Non-normative system limits	see Sec. 4.4.4.4 and 7.3.3
<b>X</b>	<b>X01 to X03</b>	Configurable switch positions	see Sec. 7.2.1



### Notice

① The table lists only the available switch positions. A detailed description of the operator functions (input procedure) can be found in the relevant Sec. (“Meaning / Procedure” column).

## 8.4 Reset

The ASD 532 can be reset after a triggered event by:

- Pressing the “Reset” pushbutton locally on the ASD or
- Briefly actuating the “External reset” input on the ASD.



### Notices

- Resetting can be triggered only after an event, but only if the criterion that resulted in the event trigger is back in its normal state (e.g. smoke level in the smoke sensor is once again below the trigger threshold, or a fault event is rectified). As a result of the reset, the ASD 532 continues to run “normally” and the fan does not stop.
- Local resetting (“Reset” key) does not reset a superordinate FACP. It may also happen that the reset in the ASD 532 triggers a fault in the superordinate line of the FACP.

## 8.5 Displays

### 8.5.1 Displays on the control unit

Several LEDs on the main board indicate the current state of the ASD 532.

Function / state	Indicator				
	Operation	Alarm	Fault	Det. dusty Det. dirty	Smoke level 1 to 10
System Off (no voltage)	green	red	yellow	yellow	yellow
System inactive (Reset external)	On		½ s T		
Smoke sensor Off (from FACP)	On		½ s T		
Quiescent state	On				
Pipe blockage/breakage, delay time running ①	On		1 s T		
Pipe blockage/breakage, fault triggered	On		On		
Fan tacho signal missing	On		On		
Fault triggered	On		On		
Smoke level 1 to 10 ②	On				On
Pre-signal 1, 2 or 3 ②	On				1 s T
Alarm	On	On			
Smoke sensor filter fault	On			2 s T	
Smoke sensor dusty	On			1 s T	
Smoke sensor dirty	On			½ s T	
Smoke sensor fault	On			On	
Lamp test (press “Reset” key 10 s)	1 s T	1 s T	1 s T	1 s T	1 s T



### Notices

- ① No fault triggered (triggers only after delay time has expired → “Fault” continuously lit).
  - ② The LED of the respective smoke level 1–10 (corresponds to 10–100% of alarm threshold) is continuously lit when exceeded. If a pre-signal is programmed on this level, the LED subsequently begins to flash (default: VS 1 = level 3, VS 2 = level 5, VS 3 = level 7).
- T = flashing display; ½ s cycle / 1 s cycle

### 8.5.2 Indicators on the AMB 32 main board

Besides the segment display the AMB 32 Main Board has various LEDs, with the following meaning (see also **Fig. 46**):

- Flashing point on the left-hand segment display = watchdog display (processor is running)
- Flashing on the segment display, point and **AL** = Autolearning is running;
- Flashing on the segment display, point and **FR** = filter replacement is running;
- On the segment display, flashing point on the left, point steady lit on the right = day/night control active (in **X01 – X03** only);
- LED “**WDog**” = watchdog display (processor not running → ASD has triggered a fault);
- LED **CardOk** = SD memory card present
- LED **Com** = communication with the SD memory card.

Other output and display possibilities on the segment display include:

- in switch position **d** > **RE** = event memory, see Sec. 7.8;
- in switch position **E** = event memory, see Sec. 8.5.3;
- in switch position **F** = firmware version, see Sec. 7.3.6;
- Push button “UP” = the set configuration (**A11** to **C31**, **W01** to **W44**, **X01** to **X03**), see Sec. 7.6.1;
- in switch position **V** = airflow values (volume rate of flow), see Sec. 7.6.1;
- flashing **000** = invalid entry;
- flashing **U - -** = initial reset is running;
- flashing **IA1**, **IF1**, **IP1**, **IE1** = test trigger is activated, see Sec. 7.7.2.

### 8.5.3 SD memory card operation

The SD memory card is automatically detected when the device is switched on and when the card is inserted. From then on it is monitored. Data logging begins automatically after approx. 10 s.



#### Notices

- Only industrial SD memory cards tested and approved by the manufacturer may be used (see Sec. 12.1). The use of a consumer SD memory card is to be avoided – this can lead to data loss or destruction of the SD memory card and faults on the ASD.
- Inserting the SD memory card: Before using the SD memory card, make sure it is blank (file interpretation).
- Removing the SD memory card: To avoid data loss, log off the SD memory card on the AMB 32 (switch position **o00**) before removing (see Sec. 7.3.7).

The SD memory card is inserted with the contact side facing toward the AMB circuit board and pushed into the holder until it snaps into place. Pressing the SD memory card again releases the locking mechanism and the SD memory card can then be removed from the holder.

The meaning of the LEDs **CardOk** and **Com** is described Sec. 8.5.2.

#### 8.5.3.1 Data logging on the SD memory card

**Smoke level and airflow values:** The smoke level and airflow values as well as the current status of the sampling tube network are written to the SD memory card every second (default, can be changed with “ASD Config”) and saved in **Log-Files** (\*.xls file). After 28,800 entries (corresponding to 8 hours with a logging interval of 1 s) a new **Log-File** is automatically generated. A total of 251 **log files** (L000.xls to L250.xls) can be generated for long-term logging. After the last **log file** the oldest one (L000.xls) is overwritten. The 251 **Log-Files** are sufficient to cover 83 days of data logging (with a logging interval of 1 s). The **log files** can be opened in Excel and the data processed with the diagram assistant to create charts.

**Events:** All events occurring in the ASD 532 are written to the **Event-Files** (\*.aev file). After 64,000 events a new **Event-File** is created automatically. A total of 10 **Event-Files** (E000.aev to E009.aev) can be generated for long-term logging. After the last **Event-File** the oldest one (E000.aev) is overwritten. The 10 **Event-Files** are sufficient to log over 640,000 events. The **Event-Files** can be opened with a text editor. Please refer to Sec. 8.5.3 for the interpretation of the events. There is also the possibility of importing **Event-Files** using the “ASD Config” configuration software and displaying them as real event text.







### 8.5.4 Displaying and reading out the event memory

The event memory can be called up via switch position **E**. Up to 99 events can be stored in the event memory (**E01** to **E99**), with event **E01** as the latest (more recent) event. If the memory exceeds 99 events, the oldest event is deleted. The event memory as a whole can be deleted only by the manufacturer.

Events are subdivided into groups (**G00** to **G99**) so they can be displayed using the 3 digits of the segment display. For each event group, up to 8 events can be displayed as a 3-digit code. The codes are added together and displayed if there are multiple pending events per event group.

#### 8.5.4.1 Procedure and interpretation of the event memory display

The sequence below provides an example to illustrate how the next to last event, i.e. the second most recent event, is read out (**E02**). The result shows that the smoke sensor alarm has triggered.

Measure	Display	Procedure / remarks
(1)  Briefly press key	flashing, e.g. <b>b21</b> or other	<ul style="list-style-type: none"> <li>Displays the commissioned switch positions <b>A11</b> to <b>C31</b>, <b>W01</b> to <b>W44</b>, <b>X01</b> to <b>X03</b></li> </ul>
(2)  Press key again until display on <b>E</b>	in succession <b>A / b / C / d / E</b>	<ul style="list-style-type: none"> <li>Displays switch position group <b>E</b></li> </ul>
(3)  Press key	<b>E01</b>	<ul style="list-style-type: none"> <li>Select event position <b>E01</b> (last event)</li> </ul>
(4)  Press key	<b>E02</b>	<ul style="list-style-type: none"> <li>Select event position <b>E02</b> (next to the last event)</li> </ul>
(5)  Press key	flashing after approx. 2 s, e.g. <b>G10</b>	<ul style="list-style-type: none"> <li>Displays the event group <b>G10</b>, smoke sensor events</li> </ul>
(6) Wait	flashing after approx. 2 s, e.g. <b>001</b> 	<ul style="list-style-type: none"> <li>Displays event code <b>001</b>, alarm smoke sensor</li> </ul>

**Notice**

 **Multiple codes:** If pre-signals 1 to 3 preceded the alarm release of smoke sensor, Point (6) will display code **057** as the result. It consists of the individual codes (added together) **001** (alarm), **008** (pre-signal 1), **016** (pre-signal 2) and **032** (pre-signal 3).

Please refer to Sec. 8.5.4.2 and 8.5.4.3 for a list of all the event groups and their events (codes).

## 8.5.4.2 Event groups

Event group	Purpose
<b>G00</b>	General events, part 1 (ASD On/Off, inactive, start initial reset, smoke sensor On/Off from FACP)
<b>G01</b>	General events, part 2 (time, <a href="#">Autolearning</a> , clear event memory)
<b>G02</b>	General events, part 3 (smoke sensor On/Off via "ASD Config")
<b>G03</b>	General events, part 4 (configuration change)
<b>G04</b>	General events, part 5 (reset events)
<b>G10</b>	Smoke sensor events (alarm, dust/dirt, pre-signals, alarm 2)
<b>G11</b>	Smoke sensor faults, part 1 (communication to ASD)
<b>G12</b>	Smoke sensor faults, part 2 (smoke sensor events)
<b>G13</b>	Isolate smoke sensor (Off/On, test results)
<b>G14</b>	Test trigger from <i>EasyConfig</i>
<b>G15</b>	Test trigger from "ASD Config"
<b>G16</b>	Smoke sensor filter faults, filter replacement
<b>G30</b>	Airflow monitoring sampling pipe (pipe blockage, pipe breakage, <a href="#">LS-Ü</a> parameters, airflow sensor def./lacking)
<b>G50</b>	Fan faults (tacho signal, regulator, current consumption)
<b>G60</b>	Initial reset faults (various initial reset parameters, initial reset <a href="#">time-out</a> , airflow too low)
<b>G70</b>	RIM 1, RIM 2 faults
<b>G71</b>	XLM / ML-SFD faults
<b>G73</b>	SD memory card / SIM / UIM / LIM faults
<b>G80</b>	AMB faults (undervoltage, clock, <a href="#">Autolearning</a> , day/night control)
<b>G81</b>	Operating system faults

## 8.5.4.3 Event codes within event groups

<b>G00, general events, part 1</b>													
<b>001</b>		Switch on ASD (supply voltage)											
<b>002</b>		Initial reset carried out (ASD)											
<b>004</b>		ASD switched off (inactive, via "External reset")											
<b>008</b>		ASD switched on (via "External reset")											
<b>016</b>		Smoke sensor switched off from FACP (SecuriFire – Integral)											
<b>064</b>		Smoke sensor switched on from FACP (SecuriFire – Integral)											
<b>G01, general events, part 2</b>													
<b>001</b>		Date, time set											
<b>002</b>		<a href="#">Autolearning</a> start											
<b>004</b>		<a href="#">Autolearning</a> correctly completed											
<b>008</b>		<a href="#">Autolearning</a> interrupted											
<b>016</b>		Event memory deleted											
<b>032</b>		Initial reset via "ASD Config"											
<b>G02, general events, part 3</b>													
<b>001</b>		Smoke sensor deactivated via "ASD Config"											
<b>004</b>		Smoke sensor activated via "ASD Config"											
<b>G03, general events, part 4, configuration changes</b>													
<b>000</b>	X01	<b>015</b>	W01	<b>023</b>	W09	<b>031</b>	W17	<b>039</b>	W25	<b>047</b>	W33	<b>055</b>	W41
<b>001</b>	X02	<b>016</b>	W02	<b>024</b>	W10	<b>032</b>	W18	<b>040</b>	W26	<b>048</b>	W34	<b>056</b>	W42
<b>002</b>	X03	<b>017</b>	W03	<b>025</b>	W11	<b>033</b>	W19	<b>041</b>	W27	<b>049</b>	W35	<b>057</b>	W43
<b>003</b>	A11	<b>018</b>	W04	<b>026</b>	W12	<b>034</b>	W20	<b>042</b>	W28	<b>050</b>	W36	<b>058</b>	W44
<b>005</b>	b11												
<b>007</b>	b21												
<b>009</b>	C11												
<b>011</b>	C21												
<b>013</b>	C31												

→→

Continuation:

<b>G04, general events, part 5, reset results</b>	
001	Key
002	SecuriLine
004	"ASD Config" PC program
008	External
<b>G10, smoke sensor events</b>	
001	Alarm
002	Dust
004	Dirt
008	Pre-signal 1
016	Pre-signal 2
032	Pre-signal 3
064	Alarm 2
128	Alarm OEM input
<b>G11, smoke sensor faults, part 1</b>	
001	Communication ASD <> smoke sensor
002	Unknown smoke sensor type
004	Response sensitivity too low
008	Invalid parameters
016	Fault OEM input
<b>G12, smoke sensor faults, part 2</b>	
001	Measuring chamber
002	Temperature
004	Supply voltage
008	EEPROM access error
016	EEPROM invalid data
032	Manufacturing
<b>G13, isolate smoke sensor</b>	
001	Isolated alarm
002	Isolate switched on
004	Isolate switched off (normal operation)
008	Isolated pre-signal 1
016	Isolated pre-signal 2
032	Isolated pre-signal 3
064	Isolated alarm 2
128	Isolated alarm OEM input
<b>G14, test trigger from <i>EasyConfig</i> (see G15)</b>	
<b>G15, test trigger from "ASD Config"</b>	
001	Alarm test
002	Fault test
004	Pre-signal 1 test
008	Pre-signal 2 test
016	Pre-signal 3 test
032	Test alarm 2
<b>G16, smoke sensor filter faults, filter replacement</b>	
001	Smoke sensor filter fault (service life exceeded)
016	Smoke sensor filter replacement started
<b>G30, airflow monitoring sampling pipe</b>	
001	Pipe blockage sampling pipe or filter element is not inserted (if DFU 911S is used)
002	Pipe breakage sampling pipe
004	Invalid <b>LS-Ü</b> parameters
008	Airflow sensor, defective / missing
<b>G50, fan faults</b>	
001	Tacho signal missing
002	Motor regulation outside range
<b>G60, initial reset faults</b>	
004	Initial reset <b>time-out</b>
008	Invalid parameters for initial reset

→→

## Operation

Continuation:

<b>G70, RIM 1, RIM 2 faults</b>	
001	RIM 1 missing or defective
016	RIM 2 missing or defective
064	incompatible RIM
128	too many RIMs connected
<b>G71, XLM / ML-SFD faults</b>	
004	ML-SFD missing or defective
008	too many ML-SFD connected or not permitted module combination
016	XLM missing or defective
064	too many XLMs connected
<b>G73, SD memory card / SIM / UIM / LIM faults</b>	
001	SD memory card missing or defective
002	SD memory card communication error
004	UIM missing or defective
008	too many UIM connected or not permitted module combination
016	SIM missing or defective
032	LIM missing or defective
064	too many SIMs connected
128	too many LIMs connected or not permitted module combination
<b>G80, AMB faults</b>	
001	Pressure sensor
002	Temperature sensor
004	Undervoltage
008	Clock
032	Invalid Autolearning parameters
064	Invalid day/night control parameters
<b>G81, Operating system faults</b>	
001	Mailbox unknown error
002	Mailbox error (memory is full)
004	various error
008	Timer error
016	Mailbox storage cannot be approved
032	Buffer overflow option module
064	EEPROM error

8.5.5 Operation and displays on the XLM 35 or ML-SFD

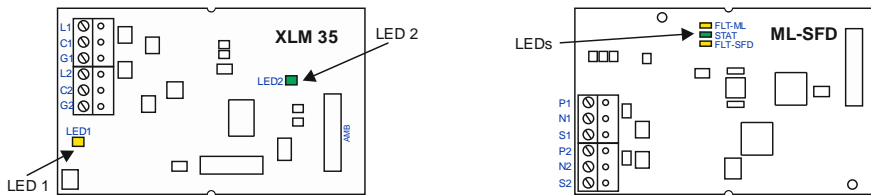

Fig. 47 XLM 35 / ML-SFD operation and display

The two LEDs on the XLM 35 indicate the communication state.

<b>LED 1 (yellow)</b>	<b>State XLM 35 ↔ addressable loop (lights only if supply from AMB is OK)</b>
Not lit	No addressable loop voltage
Continuously lit	Addressable loop voltage ok, no communication XLM ↔ Line
Flashes (normal operation)	Communication XLM ↔ Line ok
<b>LED 2 (green)</b>	<b>State ASD 532 ↔ XLM 35</b>
Not lit	No power supply from AMB 32
Flashes (normal operation)	Supply from AMB 32 ok, communication XLM ↔ ASD ok

3 LEDs on the ML-SFD indicate the communication state.

DEL	Signification
STAT (green)	<b>Continuously lit (normal operation):</b> <ul style="list-style-type: none"> <li>Power supply from SFD present</li> <li>Sub-controller and line-controller in operation</li> <li>Information M-Line ↔ SFD OK</li> </ul>
	<b>Flashes in 1 s cycle:</b> <ul style="list-style-type: none"> <li>Power supply from SFD present</li> <li>Sub-controller in operation</li> <li>Information M-Line ↔ SFD faulty (see fault LED)</li> </ul>
	<b>Not lit:</b> <ul style="list-style-type: none"> <li>No supply voltage from special fire detector</li> <li>ML-SFD defective</li> </ul>
FLT-SFD (yellow)	<b>Is not lit (normal operation):</b> <ul style="list-style-type: none"> <li>No fault</li> </ul>
	<b>Flashes in 1 s cycle:</b> <ul style="list-style-type: none"> <li>Special fire detector not compatible with ML-SFD</li> </ul>
	<b>Continuously lit:</b> <ul style="list-style-type: none"> <li>Communication fault special fire detector ↔ sub-Ctrl. (cable connection not OK)</li> </ul>
FLT-ML (yellow)	<b>Is not lit (normal operation):</b> <ul style="list-style-type: none"> <li>No fault</li> </ul>
	<b>Continuously lit:</b> <ul style="list-style-type: none"> <li>No addressable loop voltage (or no communication line controller ↔ sub-controller)</li> <li>Line controller defective</li> </ul>

8.5.6 Operation and display on the SIM 35

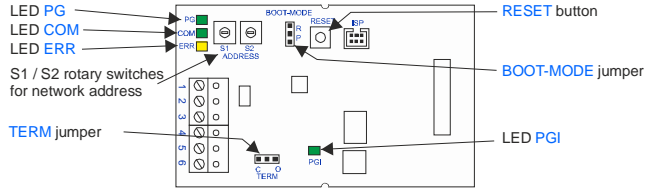

Fig. 48 SIM 35 operation and display

The functions of the rotary switches, jumpers, buttons and LEDs are shown in the following table.

The network address is set in hexadecimal code using the two rotary switches (S1 and S2). The bus termination is defined with the **TERM** jumper. This must be performed on **both sides of the network** (beginning and end) (exception: when using with NCU 900 on FidesNet only on the last SIM 35). The **BOOT-MODE** jumper is used only in production. The **RESET** button initiates a HW reset on the SIM 35. The four LEDs on the SIM 35 indicate the state of the ASD network. Please refer to Sec. 11.4 for more information about the ASD network.

Rotary switch S1 / S2		Network address													
Dec	Hex	Dec	Hex	Dec	Hex	Dec	Hex	Dec	Hex	Dec	Hex	Dec	Hex	Dec	Hex
		32	2 0	64	4 0	96	6 0	128	8 0	160	A 0	192	C 0	224	E 0
		33	2 1	65	4 1	97	6 1	129	8 1	161	A 1	193	C 1	225	E 1
1	0 1														
2	0 2	34	2 2	66	4 2	98	6 2	130	8 2	162	A 2	194	C 2	226	E 2
3	0 3	35	2 3	67	4 3	99	6 3	131	8 3	163	A 3	195	C 3	227	E 3
4	0 4	36	2 4	68	4 4	100	6 4	132	8 4	164	A 4	196	C 4	228	E 4
5	0 5	37	2 5	69	4 5	101	6 5	133	8 5	165	A 5	197	C 5	229	E 5
6	0 6	38	2 6	70	4 6	102	6 6	134	8 6	166	A 6	198	C 6	230	E 6
7	0 7	39	2 7	71	4 7	103	6 7	135	8 7	167	A 7	199	C 7	231	E 7
8	0 8	40	2 8	72	4 8	104	6 8	136	8 8	168	A 8	200	C 8	232	E 8
9	0 9	41	2 9	73	4 9	105	6 9	137	8 9	169	A 9	201	C 9	233	E 9
10	0 A	42	2 A	74	4 A	106	6 A	138	8 A	170	A A	202	C A	234	E A
11	0 B	43	2 B	75	4 B	107	6 B	139	8 B	171	A B	203	C B	235	E B
12	0 C	44	2 C	76	4 C	108	6 C	140	8 C	172	A C	204	C C	236	E C
13	0 D	45	2 D	77	4 D	109	6 D	141	8 D	173	A D	205	C D	237	E D
14	0 E	46	2 E	78	4 E	110	6 E	142	8 E	174	A E	206	C E	238	E E
15	0 F	47	2 F	79	4 F	111	6 F	143	8 F	175	A F	207	C F	239	E F
16	1 0	48	3 0	80	5 0	112	7 0	144	9 0	176	B 0	208	D 0	240	F 0
17	1 1	49	3 1	81	5 1	113	7 1	145	9 1	177	B 1	209	D 1	241	F 1
18	1 2	50	3 2	82	5 2	114	7 2	146	9 2	178	B 2	210	D 2	242	F 2
19	1 3	51	3 3	83	5 3	115	7 3	147	9 3	179	B 3	211	D 3	243	F 3
20	1 4	52	3 4	84	5 4	116	7 4	148	9 4	180	B 4	212	D 4	244	F 4
21	1 5	53	3 5	85	5 5	117	7 5	149	9 5	181	B 5	213	D 5	245	F 5
22	1 6	54	3 6	86	5 6	118	7 6	150	9 6	182	B 6	214	D 6	246	F 6
23	1 7	55	3 7	87	5 7	119	7 7	151	9 7	183	B 7	215	D 7	247	F 7
24	1 8	56	3 8	88	5 8	120	7 8	152	9 8	184	B 8	216	D 8	248	F 8
25	1 9	57	3 9	89	5 9	121	7 9	153	9 9	185	B 9	217	D 9	249	F 9
26	1 A	58	3 A	90	5 A	122	7 A	154	9 A	186	B A	218	D A	250	F A
27	1 B	59	3 B	91	5 B	123	7 B	155	9 B	187	B B	219	D B		
28	1 C	60	3 C	92	5 C	124	7 C	156	9 C	188	B C	220	D C		
29	1 D	61	3 D	93	5 D	125	7 D	157	9 D	189	B D	221	D D		
30	1 E	62	3 E	94	5 E	126	7 E	158	9 E	190	B E	222	D E		
31	1 F	63	3 F	95	5 F	127	7 F	159	9 F	191	B F	223	D F		

Jumper <b>TERM</b>	Bus termination (position "C" = active)
Position <b>O</b>	SIM 35 is <b>not</b> first or last module
Position <b>C</b>	SIM 35 is <b>first</b> or <b>last</b> module
Jumper <b>BOOT-MODE</b>	FW upgrade (production)
Position <b>R</b>	Normal position
Position <b>P</b>	Local FW upgrade on the SIM 35
Button <b>RESET</b>	SIM reset
Press	Triggers a HW reset of the SIM 35

LED <b>PG</b> (green)	State of voltage supply
Continuously lit	Power supply from AMB 32 OK
LED <b>PGI</b> (green)	State of internal voltage supply
Continuously lit	Internal voltage supply OK
LED <b>COM</b> (green)	State of communication
Flashes	Communication in progress, "ASD Config" is active
LED <b>ERR</b> (yellow)	State SIM / fault
Flashes	Address is in invalid range
Continuously lit	SIM has fault

8.5.7 Operation and display on the SMM 535

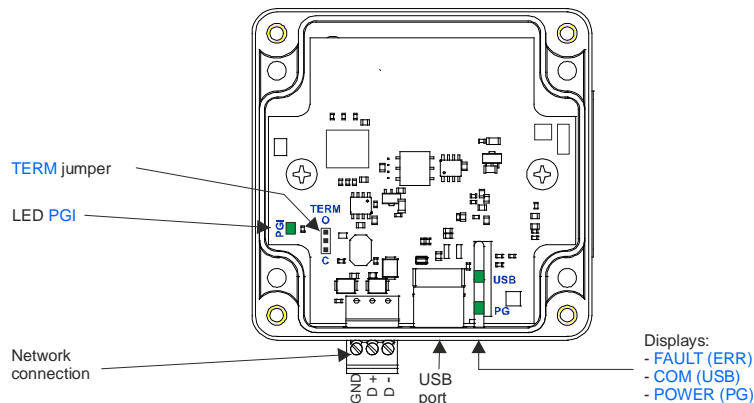

Fig. 49 SMM 535 operation and display

The functions of the jumpers and LEDs are shown in the following table.

The bus termination is defined with the **TERM** jumper. This must be performed on **both sides of the network** (beginning and end). The three LEDs on the SMM 535 indicate the state of the ASD network. Two of these are fibre optic cables on the outside of the housing (**FAULT** LED is not fitted, optional).

Jumper <b>TERM</b>	Bus termination (position "C" = active)
Position <b>O</b>	SMM 535 is <b>not</b> first or last module
Position <b>C</b>	SMM 535 is <b>first</b> or <b>last</b> module

<b>POWER (PG) (green)</b>	<b>State of voltage supply</b>
Continuously lit	Power supply from PC (USB) OK
<b>COM (USB) (green)</b>	<b>State of communication</b>
Flashes	Communication in progress, "ASD Config" is active
<b>LED PGI (green)</b>	<b>State of internal voltage supply</b>
Continuously lit	Internal voltage supply OK

No network address has to be assigned to the SMM 535.

8.6 Operation from SecuriFire / Integral with XLM 35 / ML-SFD

When connecting to the SecuriFire or Integral FACP via an **XLM 35** or **ML-SFD**, control operations and changes can be made to the ASD device configuration directly from the FACP. For this purpose the FACP user software "SecuriFire Studio" and "**In-tegral Application Center**" are used to start the "ASD Config" configuration software for access to the ASDs; operation is then carried out on the ASD 532.

# 9 Maintenance and service

## 9.1 General



### Notices

- Maintenance and service work on fire alarm systems are subject in part to country-specific laws and directives.
- Maintenance and service work may be performed only by persons trained and authorised by the manufacturer of the ASD 532.
- Depending on application, the ASD 532 must be serviced at least once a year by the manufacturer or by qualified personnel authorised and trained to do so by the manufacturer. If required (e.g. significant dirt hazard), the service interval is reduced to guarantee functional reliability. If filter boxes and/or filter units are used, the service life of the filter inserts play a role in the service interval. Depending on the level of dust and dirt in the object, filter service may vary greatly. The optimum filter service life is to be determined on site on a case by case basis. When using the filter monitoring according to Sec. 2.2.20, the filter service life is set to 3 months by default, but it can be parameterised from 1 to 24 months.
- When using a DFU 911 dust filter unit, refer to Data Sheet T 140 705 for the application-specific specifications of the filter service life.

The operator is obligated to conclude a service agreement with the manufacturer or with an installer authorised by the manufacturer if the operator does not have the required service personnel trained by the manufacturer.

The statutory national directives (DIN VDE 0833-1, VKF) governing maintenance must be observed.

Servicing, maintenance or inspection work on the ASD 532 may be necessary after an event (fire, fault).

If a detector housing has to be replaced due to a defect, the new ASD 532 is to undergo the same procedure as a first-time commissioning (initial reset required). All the customer-specific configurations have to be carried out once again on the replaced ASD 532.

For maintenance work and function checks, observe the relevant information set out in Sec. 9.3 below.

If filter-boxes or dust filter units are installed in applications with a high level of soiling risk, a "simplified" maintenance can be performed on the filter-boxes or dust filter boxes as described in Sec. 9.3.1.

## 9.2 Cleaning

Clean the detector housing with a **non-aggressive** cleaning agent (e.g. soap suds or similar).

Normally only the sampling holes need to be cleaned on the sampling pipe tube network. In applications where dirt is a major issue, it may be necessary to clean inside the sampling pipe (blow out with compressed air or nitrogen). Only **non-aggressive** cleaning agents may be used when cleaning the sampling pipe (e.g. soap and water or similar).



### Notice

Aggressive cleaning agents (such as solvents, pure petrol or other alcohol-based agents) must not be used for cleaning.

### 9.3 Maintenance checks and function checks



#### Notice

To avoid triggering fire incident controls, remote alerting and extinguishing areas when carrying out maintenance work, it is **essential** to block or switch off those systems beforehand.

For maintenance and function checks, carry out the following points:

1. Block or switch off fire incident control and remote alerting on superordinate FACP.
2. Check that the supply voltage on the FACP is set in compliance with maintenance instructions for the control panel.
3. Check that the sampling pipe inlet is correctly seated.
4. Check the air outlet for any dirt or dirt and clean if necessary.
5. If the ASD 532 is used for equipment monitoring and plug-in transitions from rigid to flexible pipe sections are in place, check that the transitions are correctly seated (no leakage).
6. Open the cover of the detector housing. Carry out the following measurements:
  - Measure the operating voltage on terminal 1 (+), 2 (-) → target value = 17.6 to 27.6 VDC.
  - Readout sampling pipe airflow value in switch setting **V** (see Sec. 7.6.1) and compare with commissioning protocol. If there is a deviation of more than half the set sensitivity (see examples ① and ②), check the sampling pipe as follows:
    - An **increase** in the value (more than 100%) tends to indicate **pipe breakage** → check the sampling pipe for leaks (junctions, fittings, etc.)
    - A **decrease** in the value (less than 100%) tends to indicate a **pipe blockage** → check the sampling pipe for pipe blockage, clean as described under **Item 9** or **Item 10**.
- ① Set **LS-Ü** sensitivity = ±20% (default); half of that = ±10%. The sampling pipe should therefore be checked if the value is below 90% or above 110%.
- ② Set **LS-Ü** sensitivity = ±50% (non-compliant with EN 54-20), half of that = ±25%. The sampling pipe should therefore be checked if the value is below 75% or above 125%.
7. Switch off the ASD (pull terminal block 1/2 and if necessary 3/4 on the AMB 32). After disconnecting the flat cable from the smoke sensor, carefully remove the sensor from the ASD.
8. Use a soft, dry paintbrush to clean the inside of the smoke sensor chamber and the insect protection screen. Oil-free compressed air or nitrogen can also be used for cleaning.



#### Notice

Do not use compressed air either to blow out or open the smoke sensor. Improper handling can affect the response characteristics. Only the manufacturer is authorised to clean dirty smoke sensors. The smoke sensors are monitored for dust and dirt; their states are displayed on the control unit. If required the smoke sensor must be replaced.

After cleaning the smoke sensor chambers, re-insert the smoke sensor into the ASD.



Continuation:

9. If it is necessary to clean the sampling pipe as indicated under **Item 6**, carry out the following measures (possibly also according to **Item 10**):
- Clean all sampling holes in the entire sampling pipe tube network. Tobacco pipe cleaners can be used for this purpose.
  - If the sampling holes are not accessible, the entire sampling pipe tube network can be blown out from the detector housing using oil-free compressed air or nitrogen. This is done via the manual ball valve or from the loosened screw-junction piece (pipe connection) of the last accessory part in the direction of the sampling pipe network.



### Notice

Blowing out from inside the smoke sensor chamber (through the fan) can damage the fan and is therefore not permitted.

- If present, open the accessory parts (water retaining box, dust filter unit, detector boxes) and clean with a soft dry brush. Oil-free compressed air or nitrogen can also be used for cleaning. Replace the filter element in the dust filter unit (see also Data Sheet T 140 705). When finished, close the accessory parts again.
  - After cleaning the sampling pipe, re-connect it correctly to the ASD 532.
10. In applications where dirt is a major issue, it may be necessary to clean the air-flow sensor. For this purpose (see Sec. 9.4.3) take it out of the holder and clean with a soft, dry brush → **Caution: Do not clean or touch the sensor surface with your fingers.** Then re-insert the air-flow sensor as indicated in Sec. 9.4.3 → make sure it is correctly seated inside the holder.
11. Switch the ASD back on again and wait until the fan has reached its optimal speed (at least 2 min).
12. Check fault triggering, alarm release and correct alarm transmission to the FACP as described in Sec. 7.7. Log the completed tests in the commissioning protocol.
13. Read out the air-flow values  $\dot{V}$  once again. If the values set out under **Item 6** are still outside the tolerance range, the airflow monitoring will have to be readjusted (initial reset as described in Sec. 7.3.5).



### Notices

- A new initial reset is not usually necessary after cleaning work on the sampling holes (cleaning restores the commissioning state). If an initial reset is necessary nonetheless after the work set out under **Item 13**, it may **only** be carried out once it has been ensured that all possible measures for cleaning the sampling pipe have been carried out (incl. a new filter element).
- If an initial reset is carried out with blocked sampling holes, there is the danger that insufficient air samples or no air samples will be aspirated and hence the ASD 532 can no longer trigger an alarm.

14. If maintenance or repair work was carried out on the ASD 532 (including the sampling pipe) as a result of servicing check, a new initial reset may be necessary (see Sec. 7.3.5).
15. All measurements and tests carried out are to be entered and signed for in the commissioning protocol. The completed commissioning protocol is to be stored with the ASD. If required, a copy can be made and stored in the system dossier.
16. After completion of the servicing check, close the detector housing once again.

### 9.3.1 Filter replacement on dust filter units

If a "Filter fault (service life exceeded)" fault trigger occurs when filter monitoring is activated and after expiry of the configured filter service life, the filter element in a dust filter unit must be replaced. When the expired filter service life (read out via *EasyConfig* switch position **d > RE**) is periodically checked, the replacement can take place before the fault is triggered. See also Sec. 7.8.

To replace the filter element, the "Filter replacement" function must be activated on the ASD (via the "Reset" key, *EasyConfig* or "ASD Config"). When filter replacement is activated, the aspirating smoke detector is set to the "Isolate" state. This insures that during the replacement work falling dust particles from the filter element do not cause a false alarm. After the filter has been replaced, the "Filter replacement" procedure is completed by pressing the "Reset" key on the ASD. This cancels the "Isolate" state and resets the fault on the ASD. The "Filter service life" monitoring is restarted at 0 (see Sec. 7.8).

### 9.4 Replacing units



#### Notice

Defective units such as the AMB 32, smoke sensor, airflow sensor and fan may only be replaced in the de-energised state (with terminal block ½ and possibly ¾ unplugged from the AMB 32).

#### 9.4.1 Replacing the smoke sensor

The smoke sensor must be replaced if defective or if there is a dirt message.

To replace the smoke sensor proceed according to Sec. 6.3. It is important to ensure that the new smoke sensor has the same alarm sensitivity range as the old one (SSD 532-1, -2, -3).

#### 9.4.2 Replacing the aspirating fan unit

To replace the AFU 32 aspirating fan unit, the AMB 32 main board must be removed. To do so, carefully unplug all the internal cable connections (including fan connection). The plug-in terminals 1 to 21 do not necessarily have to be unplugged. After removing the retainer screws on the AMB 32 using a **Torx T10 screwdriver**, the AMB 32 can be lifted up toward the cable in-feeds and the retaining screws on the aspirating fan unit are then accessible. To dismantle the aspirating fan unit, remove the two screws **A** using a **Torx T15 screwdriver** (see Fig. 50).

To mount the new fan, proceed in the reverse sequence. **Important:** Before screwing on the replacement fan, the supplied spacers must be inserted into their fastening holes.

The connection cable must be placed in **B**.



#### Notice

After replacing the aspirating fan unit, it is imperative to carry out a new initial reset (see Sec. 7.3.5).

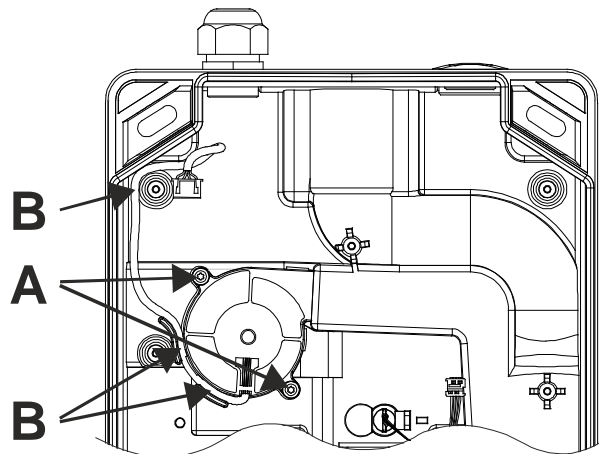

Fig. 50 Removing the aspirating fan unit

### 9.4.3 Replacing the airflow sensor



#### Notices

- When removing and mounting the airflow sensor, make sure that the sensor element is not damaged (i.e. does not break). Do not pull on the connection wires.
- After replacing an airflow sensor (new sensor), it is imperative to carry out a new initial reset (see Sec. 7.3.5).

Remove connector **A** of the airflow sensor on the AMB 32. To remove an airflow sensor, gently press lock tab **B** towards the connector plug. The airflow sensor can then be carefully pulled out of its holder by gripping tab **C** with thumb and index finger → **Attention: do not pull on the connection wires of the airflow sensor.** To install the new airflow sensor proceed in the reverse sequence. It is important to note the installation position (anti-twist safeguard) of the airflow sensor and that it is correctly seated in its holder. To do so, press the airflow sensor on grip tab **C** towards the housing base until the lock tab snaps over the airflow sensor → **Attention: do not press on the connection wires of the airflow sensor.**

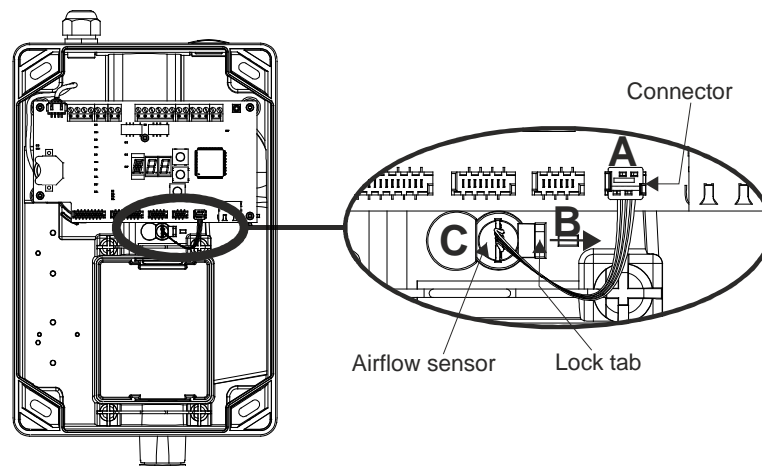

Fig. 51 Removing the airflow sensors

### 9.4.4 Replacing the AMB 32 Main Board

To replace the AMB 32 Main Board, unplug all the plug-in terminals with installation wires. Likewise, all internal cable connections (flat cable connectors) must also carefully be unplugged. Once the 5 fastening screws of the AMB 32 have been removed using a **Torx T10 screwdriver**, the AMB 32 can be replaced. To install the new AMB 32, proceed in the reverse sequence.



#### Notices

- When connecting the new AMB 32, take note of the correct assignment of the terminals and flat cable connectors (see Fig. 5).
- After replacing the AMB 32 it is imperative to carry out a new initial reset (see Sec. 7.3.5). Likewise, all customer-specific configurations and project-specific settings from the "ASD PipeFlow" configuration software must be carried out once again. To do so, proceed according to Sec. 7.3.1 and 7.3.2.

### 9.5 Disposal

The ASD 532 aspirating smoke detector and its packaging consist of recyclable material that can be disposed of as described in Sec. 9.5.1.

#### 9.5.1 Materials used



#### Recycling

All raw materials and other materials used in the ASD 532 and all the technologies used in manufacturing are ecologically and environmentally friendly in compliance with ISO 14000.



All waste resulting from assembly (packaging and plastic parts) can be recycled and should be disposed of accordingly.

Devices, sampling pipes or parts thereof that are no longer used should be disposed of in an environmentally-friendly manner.

The manufacturer of the ASD 532 is obliged to take back any devices and sampling pipes that are defective or no longer used, for eco-friendly disposal. For this purpose the manufacturer has implemented a monitored and approved disposal system. This service is available worldwide at cost price.

##### Materials used in the ASD 532:

Detector housing	PC / ABS
Smoke sensor SSD 532	Lexan (PC)
Fan housing / fan wheel	PBTP / PBTP
Fan electric motor	PU / Cu / barium ferrite powder
Circuit boards, general	Epoxy resin hard paper
Soldering process	Environmentally-friendly manufacturing compliant with RoHS
Foil on control unit	PE
Sampling tubes	ABS / PA
Fittings	ABS / PA
Pipe clamps	PA
ABS adhesives	ABS / solvent MEK (methyl, ethyl, ketone)



#### Notice with PVC plastics

Because PVC plastics when burned produce toxic, corrosive and environmentally damaging combustion products, the use of PVC is not permitted in many applications. The relevant construction regulations must be observed.

##### Ecology:

PVC plastics cannot be manufactured and disposed of without environmental impact. The recycling of PVC is possible only up to a limited degree. Please refer to the danger notice above.

Sampling tubes	PVC, see danger notice above
Fittings	PVC, see danger notice above
PVC adhesives	PVC / solvent tetrahydrofuran, cyclohexanone

## 10 Faults

### 10.1 General

When troubleshooting, do not make any on-site modifications to the printed circuit boards. This applies in particular to replacing or changing soldered components. Defective printed circuit boards and units are to be completely replaced by the corresponding spare part according to Sec. 12.1. No repairs of defective printed circuit boards or units will be undertaken by the manufacturer. It is nevertheless possible to return complete ASD devices to be checked if there is a complaint or if a guarantee is the issue.



#### Notice

Printed circuit boards are to be replaced or changed only by trained and qualified personnel. Handling is permissible only when the measures for protection against electrostatic discharge are observed and heeded.

### 10.2 Warranty claims

Failure to observe the aforementioned rules of conduct will invalidate any warranty claims and manufacturer's liability for the ASD 532.



#### Notices

- Repairs to the device or parts thereof are to be carried out only by personnel trained by the manufacturer. Non-observance of this regulation results in the invalidation of warranty claims and the manufacturer's liability concerning the ASD 532.
- All repairs and troubleshooting measures are to be documented.
- The ASD 532 must undergo a function check following a repair or troubleshooting measure.

## Faults

### 10.3 Finding and rectifying faults

#### 10.3.1 Fault states

In the event of a fault the fault profile can be localised using the event memory and the corresponding event code display, which is obtained using the segment display on the AMB 32 (switch position **E**). The following table lists the event codes of possible fault states and how to rectify them. A list of all the event codes is provided in Sec. 8.5.4.3.



#### Notice

**Multiple codes:** If there are multiple events for any given event group, the display readings are added together. Example: Display **012** = event code **004** and **008**.

<b>G10, smoke sensor events</b>			
<b>Code</b>	<b>Meaning:</b>	<b>Check:</b>	<b>Possible causes and remedy:</b>
<b>002</b>	Dust	Check smoke sensor chamber, sampling pipe and dust filter unit for dust deposits	<ul style="list-style-type: none"> <li>• Clean interior of smoke sensor chamber and insect protection screen</li> <li>• Check and clean sampling pipe and, if necessary, dust filter unit</li> <li>• Replace smoke sensor</li> </ul>
<b>004</b>	Dirt	Check smoke sensor chamber, sampling pipe and dust filter unit for dirt deposits	<ul style="list-style-type: none"> <li>• Clean interior of smoke sensor chamber and insect protection screen</li> <li>• Check and clean sampling pipe and, if necessary, dust filter unit</li> <li>• Replace smoke sensor</li> </ul>
<b>G11, smoke sensor faults, part 1</b>			
<b>Code</b>	<b>Meaning</b>	<b>Check:</b>	<b>Possible causes and remedy:</b>
<b>001</b>	Communication ASD <-> smoke sensor	Flat cable connection AMB, smoke sensor	<ul style="list-style-type: none"> <li>• Flat cable not correctly attached or defective → check, replace</li> <li>• Smoke sensor defective → replace</li> <li>• AMB defective → replace</li> </ul>
<b>002</b>	Unknown smoke sensor type (production fault)	Smoke sensor	<ul style="list-style-type: none"> <li>• Replace smoke sensor</li> </ul>
<b>004</b>	Response sensitivity too low	Correct smoke sensor installed SSD 532-1, -2, -3	<ul style="list-style-type: none"> <li>• Selected response sensitivity is too low for the deployed smoke sensor type</li> <li>• Use different smoke sensor</li> <li>• Increase response sensitivity</li> </ul>
<b>008</b>	Invalid parameters (production fault)	Smoke sensor	<ul style="list-style-type: none"> <li>• Replace smoke sensor</li> </ul>
<b>G12, smoke sensor faults, part 2</b>			
<b>Code</b>	<b>Meaning</b>	<b>Check:</b>	<b>Possible causes and remedy:</b>
<b>001</b>	Measuring chamber	Smoke sensor	<ul style="list-style-type: none"> <li>• Smoke sensor defective → replace</li> </ul>
<b>002</b>	Temperature	ASD ambient temperature Smoke sensor	<ul style="list-style-type: none"> <li>• Adhere to ambient temperature specifications</li> <li>• Smoke sensor defective → replace</li> </ul>
<b>004</b>	Supply voltage	Check ASD operating voltage AMB, smoke sensor	<ul style="list-style-type: none"> <li>• Set operating voltage correctly</li> <li>• AMB defective → replace</li> <li>• Smoke sensor defective → replace</li> </ul>
<b>008</b>	EEPROM access error	Smoke sensor	<ul style="list-style-type: none"> <li>• Smoke sensor defective → replace</li> </ul>
<b>016</b>	EEPROM invalid data	Smoke sensor	<ul style="list-style-type: none"> <li>• Smoke sensor defective → replace</li> </ul>
<b>032</b>	Production	Smoke sensor	<ul style="list-style-type: none"> <li>• Smoke sensor defective → replace</li> </ul>
<b>G16, smoke sensor filter faults</b>			
<b>Code</b>	<b>Meaning</b>	<b>Check:</b>	<b>Possible causes and remedy:</b>
<b>001</b>	Filter fault (service life exceeded)	① Check of whether the filter service life is correctly configured for the object-specific ambient dust and soiling load.	<ul style="list-style-type: none"> <li>• Insert filter element</li> <li>• If ① applies → increase filter service life</li> </ul>

→→

Continuation:

<b>G30, airflow monitoring sampling pipe</b>			
<b>Code</b>	<b>Meaning</b>	<b>Check:</b>	<b>Possible causes and remedy:</b>
001	Pipe blockage sampling pipe or filter element is not inserted (if DFU 911S is used)	Sampling pipe, air outlet on the ASD, dust filter unit, filter element soiled (or "not inserted" in DFU 911S), LS sensor	<ul style="list-style-type: none"> <li>• Check sampling pipe for pipe blockage (sampling holes, air outlet)</li> <li>• Check and clean filter-box/filter unit</li> <li>• Filter element is not inserted (if DFU 911S is used)</li> <li>• Check and clean LS sensor</li> </ul>
002	Pipe breakage sampling pipe	Sampling pipe, LS sensor	<ul style="list-style-type: none"> <li>• Check sampling pipe for pipe breakage</li> <li>• Check maintenance hole</li> <li>• Sampling pipe not correctly fitted</li> <li>• Junctions open (fittings, flexible transitions)</li> <li>• Check and clean LS sensor</li> </ul>
004	Invalid LS-Ü parameters	sampling pipe	<ul style="list-style-type: none"> <li>• Outside of range (working point)</li> <li>• Check and clean LS sensor</li> <li>• LS sensor defective → replace</li> </ul>
008	Airflow sensor, defective / missing	Airflow sensor Connection line	<ul style="list-style-type: none"> <li>• Not fitted, not mounted</li> <li>• Connection line defective</li> <li>• LS sensor defective → replace</li> </ul>
<b>G50, fan faults</b>			
<b>Code</b>	<b>Meaning</b>	<b>Check:</b>	<b>Possible causes and remedy:</b>
001	Tacho signal missing	Check fan terminals (green wire)	<ul style="list-style-type: none"> <li>• Poor connection</li> <li>• Fan defective → replace</li> <li>• AMB defective → replace</li> </ul>
002	Motor regulation outside range	Check ASD operating voltage, Check fan connection	<ul style="list-style-type: none"> <li>• Set operating voltage correctly</li> <li>• Fan defective → replace</li> <li>• AMB defective → replace</li> </ul>
<b>G60, initial reset faults</b>			
<b>Code</b>	<b>Meaning</b>	<b>Check:</b>	<b>Possible causes and remedy:</b>
004	Initial reset time-out	Motor run-in time	<ul style="list-style-type: none"> <li>• Failure to observe waiting time before initial reset</li> <li>• Carry out new initial reset</li> </ul>
008	Invalid parameters for initial reset	Sampling pipe specifications	<ul style="list-style-type: none"> <li>• Observe sampling pipe specifications</li> <li>• Initial reset was interrupted (by "ASD Off") → new initial reset</li> </ul>

→→

## Faults

Continuation:

<b>G70, RIM 1, RIM 2 faults</b>			
<b>Code</b>	<b>Meaning</b>	<b>Check:</b>	<b>Possible causes and remedy:</b>
001	RIM 1 missing or defective	Flat cable connection Module	<ul style="list-style-type: none"> <li>Flat cable not correctly attached or defective → check, replace</li> <li>Module removed and not logged off</li> <li>Module defective → replace</li> </ul>
016	RIM 2 missing or defective		
064	Incompatible RIM	Note the production version, should be greater than 181214	<ul style="list-style-type: none"> <li>Replace RIM</li> </ul>
128	too many RIMs connected	Number of RIMs	<ul style="list-style-type: none"> <li>only 2 RIM permitted!</li> </ul>
<b>G71, XLM / ML-SFD faults</b>			
<b>Code</b>	<b>Meaning</b>	<b>Check:</b>	<b>Possible causes and remedy:</b>
004	ML-SFD missing or defective	Flat cable connection Module	<ul style="list-style-type: none"> <li>Flat cable not correctly attached or defective → check, replace</li> <li>Module was removed without logging off</li> <li>Module defective → replace</li> </ul>
008	too many ML-SFD connected or not permitted module combination	Number of ML-SFDs Module combination	<ul style="list-style-type: none"> <li>only 1 ML-SFD permitted!</li> <li>no combination with XLM, UIM possible</li> </ul>
016	XLM missing or defective	Flat cable connection Module	<ul style="list-style-type: none"> <li>Flat cable not correctly attached or defective → check, replace</li> <li>Module removed and not logged off</li> <li>Module defective → replace</li> </ul>
064	too many XLMs connected	Number of XLMs	<ul style="list-style-type: none"> <li>only 1 XLM permitted!</li> </ul>
<b>G73, SD memory card / SIM / UIM / LIM faults</b>			
<b>Code</b>	<b>Meaning</b>	<b>Check:</b>	<b>Possible causes and remedy:</b>
001	SD memory card missing or defective	SD memory card	<ul style="list-style-type: none"> <li>SD memory card was removed without logging off</li> <li>SD memory card defective → replace</li> </ul>
002	SD memory card communication error	SD memory card AMB	<ul style="list-style-type: none"> <li>SD memory card defective → replace</li> <li>AMB defective → replace</li> </ul>
004	UIM missing or defective	Flat cable connection Module	<ul style="list-style-type: none"> <li>Flat cable not correctly attached or defective → check, replace</li> <li>Module was removed without logging off</li> <li>Module defective → replace</li> </ul>
008	too many UIM connected or not permitted module combination	Number of UIMs Module combination	<ul style="list-style-type: none"> <li>only 1 UIM permitted!</li> <li>no combination with XLM, ML-SFD, SIM, LIM possible</li> </ul>
016	SIM missing or defective	Flat cable connection Module	<ul style="list-style-type: none"> <li>Flat cable not correctly attached or defective → check, replace</li> <li>Module removed and not logged off</li> <li>Module defective → replace</li> </ul>
032	LIM missing or defective	Flat cable connection Module	<ul style="list-style-type: none"> <li>Flat cable not correctly attached or defective → check, replace</li> <li>Module was removed without logging off</li> <li>Module defective → replace</li> </ul>
064	too many SIMs connected	Number of SIMs	<ul style="list-style-type: none"> <li>only 1 SIM permitted!</li> </ul>
128	too many LIM connected or not permitted module combination	Number of LIMs Module combination	<ul style="list-style-type: none"> <li>only 1 LIM permitted!</li> <li>no combination with SIM, UIM possible</li> </ul>

→→

Continuation:

<b>G80, AMB faults</b>			
<b>Code</b>	<b>Meaning</b>	<b>Check:</b>	<b>Possible causes and remedy:</b>
004	Undervoltage	Operating voltage < 13.0 VDC Conductor cross-section	<ul style="list-style-type: none"> <li>• Conductor cross-section too weak → must be enlarged</li> <li>• Voltage of the power supply not OK → check and correct if needed</li> </ul>
008	Clock	Lithium battery Clock setting	<ul style="list-style-type: none"> <li>• Isolation strip still present on the lithium battery → remove</li> <li>• Clock is not set</li> <li>• Lithium battery defective → replace</li> </ul>
032	Invalid Autolearning parameters	Autolearning configuration AMB	<ul style="list-style-type: none"> <li>• Re-configure Autolearning ("ASD Config")</li> <li>• AMB defective → replace</li> </ul>
064	Invalid day/night control parameters	Day/night control configuration AMB	<ul style="list-style-type: none"> <li>• Re-configure day/night control ("ASD Config")</li> <li>• AMB defective → replace</li> </ul>
<b>G81, Operating system faults</b>			
<b>Code</b>	<b>Meaning</b>	<b>Check:</b>	<b>Possible causes and remedy:</b>
all	see Sec. 8.5.4.3	FW / AMB	<ul style="list-style-type: none"> <li>• HW reset</li> <li>• FW upgrade</li> <li>• AMB defective → replace</li> </ul>

# 11 Options

## 11.1 Sampling pipe

If the sampling pipe is being used in extremely corrosive environments, provide for sufficiently resistant tube materials. Please contact the manufacturer of the ASD 532 for the material specifications.



### Notices

- Tube materials other than those listed in Sec. 5.3 may be used only after consulting with the manufacturer of the ASD 532 and with his written consent.
- Only use tubes (material, supplier, dimensions) which have been tested and approved by the manufacturer of the ASD 532 (see also Sec. 5.3).

## 11.2 Use under extreme conditions

Applications with extremely high levels of dust and/or dirt, extreme temperature ranges and/or atmospheric humidity outside the specified limit values require the use of accessory parts as instructed by the manufacturer, e.g.:

- Dust filter unit;
- Dirt trap box;
- Dust retaining box;
- Water retaining box;
- Manual ball valve for sporadic cleaning of the sampling pipe using compressed air;
- Automatic blow-out device;
- Insulation of the sampling pipe;
- Use of cooling sections in the sampling pipe



### Notices

- Operation and application under extreme conditions may be implemented only after consulting with the manufacturer and under his supervision.
- The use of the aforementioned accessory parts is subject to a sampling pipe calculation using "ASD PipeFlow".
- The initial reset during commissioning must be carried out with the accessory parts required for operation under extreme conditions.
- If an additional unit is retrofitted to an ASD 532 already installed, a new initial reset must be carried out.

## 11.3 Use of detector boxes

Additional detector boxes (e.g. REK 511) may have to be used in the sampling pipe to create detection areas (e.g. horizontal localisation). The applicable country-specific guidelines must be observed (e.g. DIN VDE 0833-2, Germany; VKF, Switzerland). For more information on the REK 511 detector box, please refer to the separate data sheet (T 135 422).



### Notices

- The REK 511 detector box cannot be operated from the ASD 532. The REK 511 detector box has to be connected directly from the FACP using an appropriate addressing module.
- When using detector boxes, it's necessary to carry out a sampling pipe calculation using "ASD PipeFlow".

## 11.4 ASD network

The ASD network can be implemented in different ways:

- on “ASD Config” via RS-485 interface from SIM 35 / SMM 535, max. 250 participants, Sec. 11.4.1;
- on “ASD Config” via Ethernet interface from AMB 32, max. 250 participants, Sec. 11.4.2;
- on FidesNet via RS-485 interface from SIM 35 / NCU 900 or via Ethernet interface from AMB 32, max. 100 participants, Sec. 11.4.3.

A combination of both principles (RS-485 and Ethernet) is possible, but the maximum number of 250 participants (100 for FidesNet) in the overall network must be adhered to. A combination of ASD 532 and ASD 535 is possible in an ASD network.



### Notices

- The normative alarm transmission of the ASD 532 to the superordinate centre does not take place via the ASD network. For that purpose the “Alarm” / “Fault” relays in the ASD or the SecuriFire / Integral addressable loop are to be used from the XLM 35 or ML-SFD.
- The ASD network cannot be combined with the ADW network.

### 11.4.1 ASD networking to “ASD Config” via RS-485 interface from SIM 35 / SMM 535

Several ASDs can be networked with each other using the SIM 35 additional module. An ASD network can have up to 250 participants. The SMM 535 is necessary as master module in the ASD network and enables the connection to a PC. Using the “ASD Config” configuration software, all ASD 532 units present in the network can be configured, visualised and operated from the PC. The SIM 35 provides galvanic separation between the RS-485 interface and the AMB 32 (ASD 532).

Each SIM 35 and ASD 532 is assigned its own address. They are assigned based on the wiring topology in **ascending order** (see also **Fig. 52**).

The SIM 35 has two rotary switches (S1 and S2) for setting the network address (see Sec. 8.5.6).

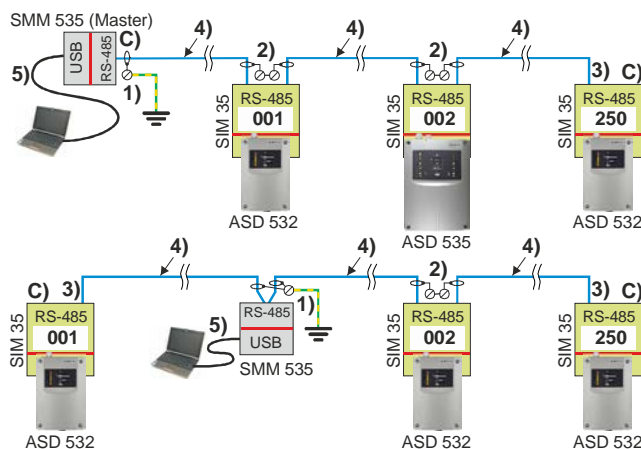

**Fig. 52 Design of an RS-485 ASD network**

- 1) Screen with equipotential bonding connected, always only on the SMM 535, do not connect on the last SIM 35; **3)**
  - 2) Screen connected by means of a lustre terminal.
  - 3) If SMM 535 is within the network, do not connect the screen on the first and last SIM 35 (beginning and end).
  - 4) Network cable: 4-wire, twisted / screened (only 3 wires are used, total length max. 1,000 m).
  - 5) USB cable, max. 3 m in length.
- C)** There must be bus termination on both sides of the network (beginning and end); jumper “**TERM**”, position “**C**”.

## 11.4.2 ASD networking to “ASD Config” via the Ethernet interface as of AMB 32

Several ASDs can be networked with one another via the Ethernet interface directly from ASD 532 (AMB 32). An ASD network can have up to 250 participants. The general rules of Ethernet technology apply with respect to a possible constellation and the design.



### Notice

It is the responsibility of the system operator and/or user of the special fire detector system to ensure IT security.

The following example shows one possible alternative for ASD networking via an Ethernet interface.



**Fig. 53 Design of an Ethernet ASD network**

### Important notice, commissioning procedure:

- The maximum length of the lines between subscribers as shown in **Fig. 53** (Switch – ASD / Switch – PC) is 100 m.
- If longer lines are necessary they can be realised using corresponding optic fibre technology.
- Every ASD requires its own IP address (ex works 169.254.1.1). The IP address must be uniquely assigned within the network and must be within the valid range (see Sec. 7.1.1.3).
- The IP address is not assigned automatically. Therefore, for assigning the IP address the initial commissioning must take place directly point-to-point on the device for each ASD (“ASD Config” > menu item “**Connection**” > “**Edit address**”, see Sec. 7.1.1.1).
- Details about establishing a connection can be found in Sec. 7.1.1.1 to 7.1.1.3.

## 11.4.3 ASD networking on FidesNet

When networking to the FidesNet, the SIM 35 additional module is also used to provide galvanic isolation. The NCU 900 is the RS-485 master module in the FidesNet. An ASD network on the FidesNet can have up to 100 participants. Instead of connecting the ASD 532 via the built-in SIM 35, networking can also be done directly from the ASD’s Ethernet interface. Further information about the FidesNet can be found in Technical Description T 140 741.

The connection of the serial interface is via the SIM 35 as shown in **Fig. 54** below. The NCU 900 is at the beginning of the installation.

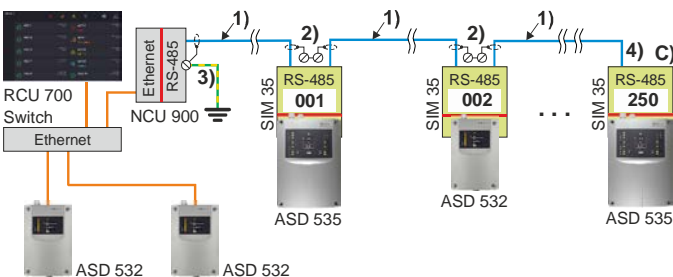

**Fig. 54 Design of a FidesNet network**

The SIM 35 has two rotary switches (S1 and S2) for setting the network address (see Sec. 8.5.6).

- 1) Network cable: 4-wire, twisted pair / screened.
  - 2) Screen connected with a lustre terminal (not included in delivery).
  - 3) Screen connected to equipotential bonding via NCU housing, always only on the NCU 900.
  - 4) Do not connect screen on last SIM 35 in the installation.
- C)** The bus termination must take place on the last SIM 35 (jumper “**TERM**”, position “**C**”).

## 12 Article numbers and spare parts

### 12.1 Detector housings and accessories

Designation	Article no.
Aspirating Smoke Detector ASD 532-1	11-2000003-01-XX
Smoke sensor SSD 532-1, 0.5%/m to 10%/m	11-2000004-01-XX
Smoke sensor SSD 532-2, 0.1%/m to 10%/m	11-2000004-02-XX
Smoke sensor SSD 532-3, 0.02%/m to 10%/m	11-2000004-03-XX
SecuriLine eXtended Module XLM 35 incl. mounting set	11-2200003-01-XX
M-Line module ML-SFD incl. mounting set	11-2200015-01-XX
RIM 36 Relay Interface Module incl. mounting set	11-2200005-01-XX
SIM 35 Serial Interface Module incl. mounting set	11-2200000-01-XX
SMM 535 Serial Master Module	11-2200001-01-XX
SD memory card (industrial version)	11-4000007-01-XX
Printed circuit board AMB 32 main board	11-2200013-01-XX
Aspirating Fan Unit AFU 32, complete	11-2200008-01-XX
Air Flow Sensor AFS 32	11-2200007-01-XX
Insect Protection Screen IPS 35 (set of 2)	11-2300012-01-XX
Lithium battery	11-4000002-01-XX
Cable screw union M20 (set of 10)	11-4000003-01-XX
Cable screw union M25 (set of 10)	11-4000004-01-XX
Adapters for US cable screw unions AD US M-Inch	11-2300029-01-XX
UMS 35 Universal Module Support	4301252.0101

### 12.2 Sampling pipe and accessories

The article numbers of all the available parts for the sampling pipe (tubes, fittings, etc.) are listed in a separate document (T 131 194).

## 13 Technical data

Type	ASD 532		
Supply voltage range	14 to 30 (UL/FM = 16.4 to 27)		VDC
Max. power consumption, measured in Fan speed level III and at →	14 VDC ①	typical 24 VDC	
ASD 532-1	Quiescent/fault Alarm	approx. 170 approx. 200	approx. 100 approx. 115 mA mA
	additionally with 1x RIM 36 (all relays triggered)	approx. 30	approx. 15 mA
	additionally with 2x RIM 36 (all relays triggered)	approx. 60	approx. 30 mA
	additionally with XLM 35 / ML-SFD	approx. 15	approx. 5 mA
	additionally with SIM 35	approx. 15	approx. 5 mA
	SMM 535 (not from ASD but rather from PC via USB connection)		max. 100 mA
Switch-on current peak ② (caused by EMC protection elements on the ASD supply input)			approx. 5 A for max. 1 mx
Sampling pipe length	see Sec. 4.2.1		
Sampling pipe diam., typical (inner/outer)	Ø 20 / 25 mm		
Max. number of sampling holes	see Sec. 4.2.1		
Sampling hole diameter	Ø 2 / 2.5 / 3 / 3.5 / 4 / 4.5 / 5 / 5.5 / 6 / 6.5 / 7 mm		
Response range	EN 54-20, class A, B, C		
Protection type compliant with IEC 60529 / EN 60529	54		IP
Ambient conditions compliant with IEC 60721-3-3 / EN 60721-3-3	3K5 / 3Z1		class
Extended ambient conditions:			
• Detector housing temperature range	-20 – +60 (UL max. +40)		°C
• Sampling pipe temperature range	-20 – +60 ③		°C
• Max. permissible temperature fluctuation in detector housing and sampling pipe operation	20 ③		°C
• Max. permissible storage temperature for detector housing (without condensation)	-30 – +70		°C
• Ambient pressure difference between detector housing and sampling pipe (sampling holes)	must be identical		
• Humidity ambient condition for detector housing (transient without condensation)	95 ③		% rel. h
• Humidity ambient condition (continuous)	70 ③		% rel. h
Max. loading capacity, relay contact	50 (UL max. 30)		VDC
	1		A
	30		W
Max. loading capacity per OC output (dielectric strength 30 VDC)	100		mA
Plug-in terminals	2.5 mm <sup>2</sup>		
Cable entry for cable Ø	Ø 5 – 12 (M20) / Ø 9 – 18 (M25) mm		
Sound pressure level for fan speed level I / II / III	25 / 31 / 39 dB (A) / 1 m		
Housing material	ABS blend, UL 94-V0		
colour	grey 280 70 05 / anthracite violet 300 20 05 RAL		
Approvals	EN 54-20 / EN 54-27 / FM 3230 – 3250 / UL 268 7 <sup>th</sup> Ed / UL 268A 4 <sup>th</sup> Ed / ULC-S529 4 <sup>th</sup> Ed		
VdS approval	G 215101		
Dimensions ASD 532-1 (W x H x D)	195 x 333 x 140 mm		
Weight ASD 532-1 (incl. SSD 532-x)	2,000 g		



### Notices

- ① Power consumption at maximum permitted voltage drop in the electrical installation (decisive value for calculating the conductor cross-section).
- ② May cause the protective circuit to trigger immediately in the case of power supplies with overload protective circuits (primarily in devices with no emergency power supply and output current of < 1.5 A).
- ③ Lower or higher temperature ranges are also possible subject to consultation with the manufacturer. The manufacturer must be consulted if the device is used in the condensation range.

## 14 List of figures

Fig. 1	General operating principle .....	15
Fig. 2	Block diagram .....	16
Fig. 3	Workflow for project-related programming.....	18
Fig. 4	Mechanical design .....	29
Fig. 5	Electrical design .....	31
Fig. 6	“ASD PipeFlow” program interface.....	35
Fig. 7	Examples of planning with “ASD PipeFlow” calculation.....	38
Fig. 8	Examples of planning without “ASD PipeFlow” calculation.....	38
Fig. 9	Sampling pipe definitions .....	39
Fig. 10	Size of sampling holes .....	42
Fig. 11	Equipment monitoring layout variants (examples).....	44
Fig. 12	Monitoring air-conditioning and ventilation ducts in compliance with EN 54-27 .....	48
Fig. 13	Air recirculation for differing climate zones .....	48
Fig. 14	Workflow for project-specific programming and adjustment .....	49
Fig. 15	Detector housing dimensioned drawing and drilling plan.....	54
Fig. 16	Open, closing and securing the detector housing.....	57
Fig. 17	Mounting position and pipe entries on the detector housing.....	58
Fig. 18	Removing the air outlet pipe plug.....	59
Fig. 19	Turning the labelling strips .....	59
Fig. 20	Cutting the tubes.....	62
Fig. 21	Assembling the tubes.....	62
Fig. 22	Vertical sampling pipe .....	62
Fig. 23	90° bend, branching point .....	62
Fig. 24	Screw-free fastening of a sampling fixture.....	63
Fig. 25	Transition from fittings to flexible tube .....	64
Fig. 26	Creating the sampling holes.....	65
Fig. 27	Mounting clips .....	65
Fig. 28	Using sampling funnels .....	65
Fig. 29	Mounting the ceiling bushing.....	66
Fig. 30	Mounting accessory parts .....	67
Fig. 31	Deploying the smoke sensors .....	69
Fig. 32	Installing additional modules .....	70
Fig. 33	Types of power supply .....	73
Fig. 34	Reset input.....	73
Fig. 35	Control via supply with relay.....	74
Fig. 36	Control via the “Reset external” input.....	75
Fig. 37	Connection to zone detection.....	76
Fig. 38	Connection on selective identification or addressable loop .....	76
Fig. 39	Connection from XLM 35 / ML-SFD .....	77
Fig. 40	Connecting the OC outputs.....	77
Fig. 41	Detector housing opened for commissioning.....	78
Fig. 42	Control and displays elements on the AMB 32.....	81
Fig. 43	Configuration overview.....	82
Fig. 44	Workflow for commissioning using EasyConfig .....	84
Fig. 45	Workflow for commissioning with “ASD Config” configuration software.....	85
Fig. 46	View of the operation and display elements .....	98
Fig. 47	XLM 35 / ML-SFD operation and display.....	107
Fig. 48	SIM 35 operation and display .....	108
Fig. 49	SMM 535 operation and display .....	109
Fig. 50	Removing the aspirating fan unit.....	114
Fig. 51	Removing the airflow sensors .....	115
Fig. 52	Design of an RS-485 ASD network .....	123
Fig. 53	Design of an Ethernet ASD network.....	124
Fig. 54	Design of a FidesNet network .....	124

## Document history

First edition      Date 15.10.2015

Index “a”      Date 31.10.2016

Most important changes compared with previous issue:

Section / Fig.		New (n) / changed (c) / deleted (d)	What / Reason
1.8	n	Reference to new Sec. 4.12, use for UL	New UL use
2.2.1 / 6.5.1	n	Supply voltage range for UL specified	New UL use
2.2.8 / 2.2.14 / 6.5.1 / 7.2.1	n	Activation of the day/night control via OEM input described.	Addition, correction
2.2.12.2 / 7.2.1	n	Notice supplemented: delay time for UL	New UL use
2.2.12.3 / 2.2.20 / 5.5.12 / 7.2.1, Table C / 7.3.4 / 7.3.5 / 7.3.6 / 7.3.7 / 7.6.1 / 7.7.2 / 7.8 / 8.3 / 8.5.2 / 8.5.4.1 / 8.5.4.2 / 8.5.4.3 / 9.1 / 9.3.1 / 10.3.1	n / c	<b>New “Filter monitoring” function:</b> <ul style="list-style-type: none"> <li>• configuration options</li> <li>• new switch position <b>d</b></li> <li>• new Sec. “Filter monitoring operation”</li> <li>• new event group <b>G16</b> with event code <b>001</b> and <b>016</b></li> <li>• maintenance on dust filter units</li> <li>• new Sec. “Filter replacement for dust filter units”</li> <li>• description of the fault conditions</li> </ul>	Extension
4.2.2	n	New section, Usable accessory materials for the sampling pipe	Addition
4.4.4.3 / 4.4.4.5 / Fig. 10	c	Correction of the system limits for E > C31 (number of sampling holes 4 instead of 5)	Spelling mistakes
4.6 / Fig. 12 / 7.3.5	n	New section, Monitoring of air-conditioning and ventilation ducts compliant with EN 54-27	Addition
4.9.1 / 6.5	n	Notice supplemented: do not use looped wire	New UL use
4.9.2	c	Notice: support terminals only for power supply line	New UL use
4.12	n	New section, use for UL	New UL use
6.2	n	Notice supplemented: for UL, replacement of the screw-junction pieces with AD US M-Inch adapter	New UL use
6.4 / 6.6.4.3	n	Notice about “EN 54-17” identification sign	Addition
6.6	c	Text correction “country-specific e.g. EN 54-4”	Correction
6.6.2 / Fig. 34	c	Terminal designation “reset input” corrected	Correction
6.6.4.3	c	Number of XLM on addressable loop	Correction
7.1.1 / 11.4.2	n / c	New section “Connect via Ethernet”, additions under “ASD networking”	Addition
7.3.4	c	Correction of the default date on <b>Y13 / M01 / d01</b>	Correction of the year number
8.1 / 8.5.1	c	Lamp test	Addition, correction
8.5.4.3 / 10.3.1	c	Correction of the event texts for <b>G81</b> / inclusion under “Fault conditions”	Text correction / addition
12.1	n	New accessory: AD US M-Inch	New UL use
13	n	Note about UL use concerning supply voltage range, temperature range, relay contact, approvals	New UL use

**Index “b”**      **Date 30.04.2018**

Most important changes compared with previous issue:

Section / Fig.		New (n) / changed (c) / deleted (d)	What / Reason
2.2.6 / 6.5.3 / 7.2.1, Table C / 7.2.2	c	Text corrections (“Sampling tube” → “Sampling pipe”)	Correction
2.2.6 / 7.2.1, Table C / 7.2.2 / 8.5.4.3 / 10.3.1	c	Text “Smoke sensor” removed, since here not necessary	Correction
2.2.8 / 6.5.1	c	Notice about prioritisation of the function day/night control removed	Correction
2.2.10 / 2.2.15	c	“Dust” fault triggering only via RIM 36	Supplemental text, correction
2.2.13	c	Autolearning interruption at “Isolate” and “Filter replacement”	Supplemental text, correction
2.2.20 / 7.8	c	Section described better (“Filter monitoring” instead of “Filter function”; the term “workdays” and the prerequisite “time” defined)	Supplemental text, correction
4.2.2 / 4.3.2 / 4.4.4.3 / 11.2 / 11.3	c	Use of accessory material when planning without ASD PipeFlow	Correction
4.2.2 / 5.5.12 / Fig. 30	n	DFU 911 duster filter unit integrated	Extension
4.4.4.3	c	New alarm thresholds, since without accessory parts	Correction
4.9.1 / 4.9.2	c	UL use: text “looped lines” and “support terminals” defined better	Supplemental text
4.10 / 13	c	“Sound pressure level” instead of “noise level”, value specification corrected	Correction
6.6.5	c	OC outputs short-circuit-proof	Supplemental text, correction
7.1.1 / 7.1.1.1 / 7.1.1.2 / 7.1.1.3 / 7.6.1 / 7.6.2 / 8.3 / 11.4.2	n / c	Extended IP address range, extended switch position <b>N</b> (factory setting IP address)	Extension
7.2.1, Table A / B	c	Various corrections of the setting range specifications (“Dirt threshold” / “LS-Ü delay” / “Start time day/night”)	Correction
8.5.2	c	Indicators “Initial reset in progress” / “Test trigger active”	Addition
10.1	c	Procedure for defective units / replacement material	Supplemental text, correction

**Index “c”**      **Date 20.06.2019**

Most important changes compared with previous issue:

Section / Fig.		New (n) / changed (c) / deleted (d)	What / Reason
1.5	c	Correction of the rating plates	Correction
4.6 / 7.3.5 / Fig. 12 / 7.3.5	c	Correction of the application EN 54-27	Correction / addition
4.7 / Fig. 13 / 5.4	c	Air recirculation, maximal 20 m omitted	Correction/expansion
4.9.2 / 13	c	RIM current consumption (all relays triggered)	Addition
4.12	c	Correction of the system limits compliant with UL 268 7 <sup>th</sup> Ed, UL 268A 4 <sup>th</sup> Ed and ULC-S529 4 <sup>th</sup> Ed	Correction / addition
6.6.4.3	c	Number of XLM on addressable loop	Correction
7.3.4	c	Display at step (17) = flashing - - - (approx. 2x)	Correction
9.1 / 9.3, point 9	n	Notice about filter service lives in DFU 911 Data Sheet	Addition
13	c	Name of standard for protection type/ambient conditions	Correction

## Document history

Index “d”      Date 13.12.2021

Most important changes compared with previous issue:

Section / Fig.		New (n) / changed (c) / deleted (d)	What / Reason
Various	n	Inclusion of ML-SFD additional module in Section / Fig.: 1.1 / 1.4 / Fig. 2 / 2.2.8 / 2.2.9 / 2.2.12.3 / 2.2.15 / 3.1 / 3.2 / Fig. 5 / 3.4 / 4.2 / 4.9.1 / 4.9.2 / 6.4 / Fig. 32 / 6.5.2 / 6.6.2 / 6.6.3.2 / Fig. 36 / 6.6.4.3 / Fig. 39 / 7.1 / 7.2 / 7.3.7 / 7.4.3 / 7.7.2 / 8.5.4.2 / 8.5.4.3 / 8.5.5 / Fig. 47 / 8.6 / 10.3.1 / 12.1 / 13	Extension
Various	n	Inclusion of UIM additional module in Section / Fig.: 1.1 / 1.4 / Fig. 2 / 2.2.15 / 3.1 / 3.2 / Fig. 5 / 3.4 / 6.4 / Fig. 32 / 7.1 / 7.3.7 / 8.5.4.2 / 8.5.4.3 10.3.1	Extension
1.1 / 1.4 / 2.2.19 / 8.5.6 / 11.4 / 11.4.1 / 11.4.3 / 11.4.3	n	Notice about FidesNet, section on ASD networking reorganised	Addition
2.2.18.3	c	Description “initial reset,” text reformulated	Correction
Various	c	Filter FBL, FBX, DFU 535 omitted from Section / Fig.: 2.2.18.3 / 4.2.2 / 4.3.1 / 4.4.1 / 4.10 / 5.4.2 / 5.5.12 / Fig. 30 / 7.8 / 9.3 / 9.3.1 / 10.3.1 / 11.2	Correction
4.2.2	c	Supplement and correction of the table “Usable accessory materials for the sampling pipe” (filters / ADBs)	Correction / addition
4.3.1	c	Notice about short pipe systems with too low volume airflow	Addition
4.4.2	c	Room monitoring of high rooms in accordance with the “FIA Code of Practice”	Correction
5.5.5 / 5.5.6 / Fig. 24 / Fig. 25 / 9.5.1	c	“Clamp” omitted (pipe clamp)	Correction
Fig. 30	c	New ADBs (instead of ADB 01A/02)	Correction / addition
8.5.4.3	c	<b>G30</b> Event code <b>001</b> , Notice on DFU 911S supplement	Correction / addition
10.3.1	c	Text adjustment for <b>G70</b> and <b>G80</b> , meaning (“Fault” omitted)	Correction
13	c	Addition of the VdS G number	Addition